



Broadcasting Products ISDB-T

Product Catalogue 3Q 2013





Screen Service

IT WORKS.

Screen Service is a worldwide known company focused on turn key and end-to-end solutions for all broadcaster needs.

With more than 20 years of experience and thousands of satisfied customers, Screen Service is the leading company in digital TV technology.





Historical Milestones

1980s

In the late 1980s Screen Service Italia (SSI) was founded in Brescia. It was active in management, assistance and trading of TV-radio systems, radio transmitters and other electronic equipment.

1990s

- SSI starts internal production of TV Transmitters and Microwave Links.
- Strategic partnership with M.B. International Srl, broadens its product portfolio with digital broadcasting technology.

2000s

- **2004:** SSI acquires a 39% stake in Innovaction S.r.l., a company which operates in projects and prototypes of electronics and transmission equipment.
- **2004:** Cape Natexis Private Equity Fund (CNPEF) and Fondamenta acquired a 60% stake in the company through SSBT S.p.A.
- **2005:** SSBT incorporates Screen Service America (SSA).
- **2005:** SSBT acquires the entire capital of M.B. International Telecom Labs S.r.l. (MBITL), a spin-off of M.B. International S.r.l.

2006s

- Screen Service System (SSS) is incorporated, entering into the system integration business with an opportunistic approach.
- **11-Jun-2007:** first day listed on the Milan Stock Exchange "Expandi Market".

2007s

- **Jun-2007:** MBITL signs agreement with Xilinx (NASDAQ – XLNX) as R&D partner for the development of several protocols in order to allow IPTV (Internet Protocol Television) to function on Xilinx's Platform.
- **Jun-2007:** Screenlogix is established and is expected to be involved in the development of a new generation of Hi-speed SuperComputers for number crunching, virtual servers and computer graphics.

- **Oct-2007:** SSBT acquires order from an important System Integrator for the supply of innovative transmitters for the broadcasting of digital terrestrial TV and mobile TV, manufactured according to the Software Defined Transmitter (SWDT) technology. The order has a value of approx. **16 million Euros.**
- **Oct-2007:** MBITL signs agreement with a major company, S&P 500 listed to develop software on embedded/digital signal processing family by utilizing the concept of "Software Defined Radio" of which MBITL is a pioneer.

2008s

- **At the end of January 2008,** Screen Service do Brasil (SSB) is incorporated and is already in a position to deliver the ISDB-T standard (also used in Japan) that has been adopted in Brazil for digital transmission.
- **Mar-2008:** record contract signed with RRD and Profit Group worth 14,5 million Euros (duration of 30 months w.e.f. 1-Apr-2008) for the supply of DVB-T equipment necessary to complete and define the digitalization process of the interregional broadcasters controlled by Profit Group.
- **Mar-2008:** financial loan of 8 million Euro granted to Profit Group (expired date 17-Mar-2011) which entitles SSBT to be the privileged supplier (first call-last refusal) of equipment necessary to the construction of the Wi-Max network of the following Italian Regions: Liguria, Toscana and the Province of Trento.
- **Mar-2008:** a call option has been granted by Profit Group for the purchase of 30% of share capital of RRD, leader in the supply of large scale solution in DVB-H technology. It can be exercised within March 2011 at a price of 7 million Euros.

2009s

- **SCREEN SERVICE acquires 100%** of RRD Reti Radiotelevisive Digitali S.r.l., a leader in the broadcast and telecommunications services industry.
- Screen Service and RRD play a primary role in the definition of the new standard for the US market, ATSC Mobile DTV (A/153), collaborating with OMVC (Open Mobile Video Coalition) and offering a complete high reliability end-to-end solution.



2010s

- **Screen Service founds Skylinks**, a newco with a long background of experiences in High Capacity Microwave Systems. Its product portfolio covers the broadcast needs but also telecom, defense, healthcare and many others.

2011s

- Tivuitalia becomes an officially authorized Italian Nationwide Network Operator.

Screen Service Broadcasting Technologies S.p.A.

Screen Service America LLC 100%

Screen Service do Brasil Ltda. 100%

Skylinks s.r.l. 100%

Tivuitalia S.p.A. 100%

Services

Have you decided to make the digital switch but cannot find a way to cover the initial cost in your budget? Screen Service Group will make it easy to afford the switch with Darwin Service.

Darwin, otherwise known as evolutionary rental, is an innovative service with a new contractual formula allowing companies looking to make the digital switch without committing to a complete investment, or incurring upfront costs.

Screen Service always supports you, for every problem you can have using our equipments, our support center will help you. Screen Service has strategically located three different support centers in different geographical areas in order to cover the extended business hours support requirement of our customers:

Italy, USA, Brazil.

Call or write us (support@screen.it), we'll do our best to deliver a fast and effective solution.



Screen Service Group does not just value your company's business until the check clears; SSBT values the customer for the duration of our partnership. We hold ourselves to a high standard concerning Customer Support and Maintenance, and provide our partners with quality assistance in either field on a multinational, multilingual level. SSBT takes pride in executing our commitment to you via your warranty conditions as quickly as possible, while still adhering to the excellence and quality we have mandated for ourselves.



The Screen Service group has, through Tivultalia, network operator capabilities, installation services, and network planning. Tivultalia has a complete worldwide database with altimeters and population and twenty years of experience in network planning and coverage simulations. Thanks to their experience, Tivultalia can gather transmission site information and deliver a complete simulation of Population coverage, Errors, disturbed signals, losses of power, SFN simulations and delay calculation, Transmitting power planning and simulations and Network optimization.

The Screen Service Group have gathered an impressive range of expertise in the broadcasting industry, giving them the credibility to advice and consult in the worldwide market for digital TV, such prestige is only given to those amongst the highest echelon in their field, confirming their vast and knowledgeable experts are among the best in the world. Concerning anything from starting out, or making the transition to digital, to telecom operators seeking insight on Mobile TV business opportunities. Screen Service Group combines perspectives to give you complete results, offering you consultants from both the technical and business facets of this industry.

Screen Service Group delivers a wide range of products encompassing all services a broadcaster needs: including everything from the playout to the transmitters. Some customers want to use a particular configuration, which can be integrated into the Screen Service system. We bring a multi-product multi-platform mindset that allows us to integrate equipment our broadcasting customer already has into the Screen Service system.



Product Customization Ability

Screen Service fits customer requests into a solution.

This page shows you just a few customizations that the Screen Service engineers are capable of, have confidence in knowing that when you tell our Sales Department what you need, you are working with over twenty years of experience to ensure that you will be provided with excellent customer service and a perfectly tailored solution.

Transmitter interlock



Matching lines for the Antenna load



Emergency button

Analog dashboard

Analog Dashboard draws the output power on air and upon loading



Switching Relay

It switches from the main transmitter to the reserve with the U-Link bypass capability





TLC/TLS on top

Panel on top of the rack with all TLC and TLS signals can also have other input options, such as ASI, 10MHz and 1PPS



Dummy Load

Motorized Thermostatic Panel to regulate temperature

Thermostatic Panel opens and closes ducts after checking the internal temperatures (68° F, 20° C) and controls the direction of hot air in order to reduce the equipment stress

Redundant Blowers

Fans alternate operation every 300 hours

Power Distribution

Power Distribution can be provided integrating an insulator transformer, a soft start circuit, absorption control, and a tilting phase circuit as well as auxiliary power input for the UPS system within the Control Unit

Screen Service also provides custom software applications tailored on any specific requirement our customers may have, such as the software which grants different types of access to the system allowing the authorized personnel working on it with various levels of authorizations.

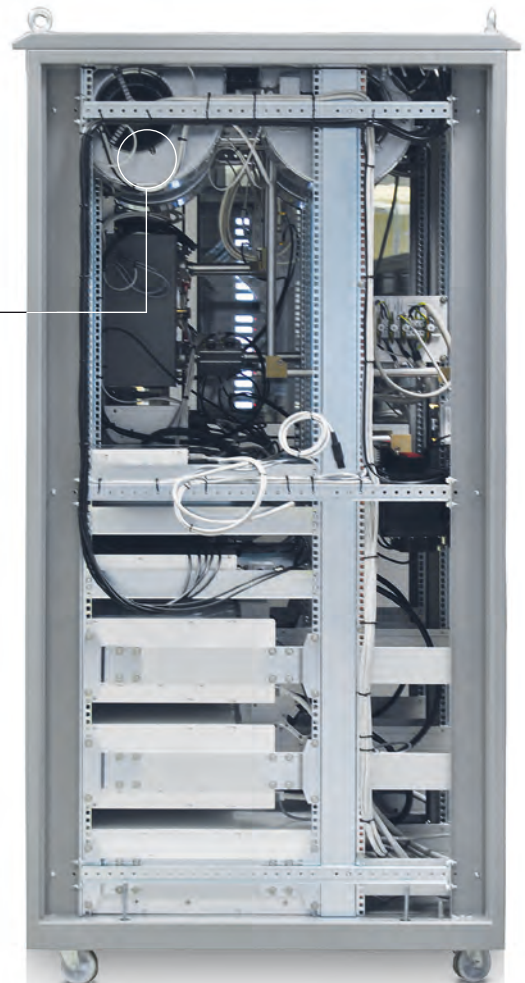

Product Portfolio



Screen Service draws the future in the broadcasting market with a wide range of advanced technology products that covers any headend, distribution, broadcast and remoting needs.

Headend



- Encoders SD, HD, H264/Decoders
- Multiplexers/Re-Multiplexers
- SFN Adapters
- Seamless ASI Switching Systems
- IRRM (Integrated Receiver and Re-Multiplexer) for Regional SFN Distribution
- Dual GPS with Seamless Switching
- Complete Head-end in a box (DVB-H) /ATSC-MH)
- T2-MI Gateway



TV Transmitters

- Multi Mode Transmitters and Transposers
- Air and Liquid Cooling
- from 1 mW to 40KW
- Analog (PAL, NTSC) and Digital (DVB-T/T2 - ATSC/MH – ISDB-Tb – DAB/T-DMB - DTMB)
- Transposers/Translator with Automatic Signal Recognition
- Gap Fillers With Automatic Digital Echo Cancelling Device



Test Measurement & Monitoring

- Broadcast Analyser
- Monitoring System
- Power Meter
- Multi Viewer



Radio Link Microwave System

- High Capacity Microwave Systems.
- 1+0, 1+1, 2+0, Split Mount and Full Indoor Hardware Configurations
- From 3.6 to 43 GHz., from QPSK to 1024QAM, Several HW configurations are available, scalable Ethernet from 1 up to 2Gpbs.
- Customizable radio links solutions.



Remote Network Management



All, Always, Anywhere under control... everything totally in your power. Functionality can be achieved with a minimum effort: this is the secret of modern technology. And this is also the result of uninterrupted development, where research and design push the competitive edge of technology. SSBT's remote control system is the result of this philosophy: "SSBT NMS System" embeds in a single product state-of-the-art technology, advanced features and easy of use. RDF (Radio Data Frontend), now in the third generation, SNMP advanced management, and NetLOBBY software are the complementary elements leveraging SSBT NMS System full power.

Table of Contents

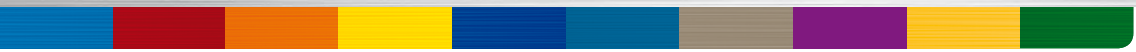

2	Headend Solutions	
ENC 323	Encoder/Decoder H.264	4
ENC 326	Two channels Multi-standard H.264 encoder tailored for Mobile TV applications	5
ENC 333A	Encoder HD/SD/1SEG, MPEG2/H.264	6
ENC 334	Four Channel SD-Encoder MPEG2/H.264	8
PRO RX SAT 2	Professional Satellite Receiver	10
PRO RX SAT 2 with Decoder	Professional Satellite Receiver with decoder	12
Service Platform Coordinator	Headend Central Manager	16
XBT 538	MFP Multiplexer (Metric Feed Packets)	18
XBT 529	Broadcast Transport Stream Multiplex	20

22		SDT ARK-6 DVB Series	
SDT 000 ARK-6	1mW rms	Driver OdBm	30
SDT 200 ARK-6	20W ps/2,5W rms	Heterodyne Transposer, Regenerative Transmitter, Transmitter	32
SDT 500 ARK-6	50W ps/12W rms	Heterodyne Transposer, Regenerative Transmitter, Transmitter	34
SDT 201 ARK-6	400W ps/150W rms	Heterodyne Transposer, Regenerative Transmitter, Transmitter	36
SDT 201 ARK-6 NC	450W ps/150W rms	Heterodyne Transposer, Regenerative Transmitter, Transmitter	38
SDT 501 ARK-6 Compact	800W ps/300W rms	Heterodyne Transposer, Regenerative Transmitter, Transmitter	40
SDT 501 ARK-6	1000W ps/350W rms	Heterodyne Transposer, Regenerative Transmitter, Transmitter	42
SDT 102 ARK-6	2000W ps/700W rms	Heterodyne Transposer, Regenerative Transmitter, Transmitter	44
SDT 202 ARK-6	3000W ps/1300W rms	Heterodyne Transposer, Regenerative Transmitter, Transmitter	46
SDT 502 ARK-6	6000W ps/2600W rms	Heterodyne Transposer, Regenerative Transmitter, Transmitter	48
SDT 532 ARK-6	9000W ps/3900W rms	Heterodyne Transposer, Regenerative Transmitter, Transmitter	50
SDT 103 ARK-6	12000W ps/5200W rms	Heterodyne Transposer, Regenerative Transmitter, Transmitter	52
SDT 123 ARK-6	12500W ps/3200W rms	Heterodyne Transposer, Regenerative Transmitter, Transmitter	54
SDT 133 ARK-6	18000W ps/7800W rms	Heterodyne Transposer, Regenerative Transmitter, Transmitter	56
SDT 203 ARK-6	24000W ps/10000W rms	Heterodyne Transposer, Regenerative Transmitter, Transmitter	58
SDT 303 ARK-6	36000W ps/15000W rms	Heterodyne Transposer, Regenerative Transmitter, Transmitter, Liquid Cooled	60
SDT 403 ARK 6	48000W ps/20000W rms	Heterodyne Transposer, Regenerative Transmitter, Transmitter, Liquid Cooled	62
SDT 603 ARK-6	72000W ps/30000W rms	Heterodyne Transposer, Regenerative Transmitter, Transmitter, Liquid Cooled	64



68	Accessories and Synchronization Systems	
SCS 300/350	Main Meter	70
SCS 500	Automatic Changeover Unit (1+1)	71
SCS 900	Automatic Changeover Unit (N+1)	74
SCS 120S	GPS Receiver, 8 x 1PPS / 5 or 10MHz Outputs - stand-alone unit.	75
SCS 120D	Dual Redundant GPS Receiver, 8 x 1PPS / 5 or 10MHz Outputs Stand-alone unit Seamless	76
GPS Smart	GPS Receiver, 4 x 1PPS / 4 x 10MHz Outputs - stand-alone unit.	78
ASI To IP Converter	ASI TO IP and IP to ASI converter	82
XBT 706D	Redundant Asi Distributor	86

88	Professional Measurement Tools	
Multiviewer MTW004	Multiviewer Monitoring System	92
Power Meter Probe	RF Portable Power Meter Probe	95
SFN Analyzer	Digital Single Frequency Network analyzer	96
GPS Tester	Broadcast GPS Validator	97
XBT 52	ASI Killer	98
TS Compare	ASI Compare & Measure	99
SSBT Broadcast Analyser	Measurement System	100

104	Contacts	
Contacts		104

Headend Solutions



Headend Solutions

Encoders, Decoders, Seamless Switching, SFN Re-Multiplexer,
MFP Multiplexer, Gateway, BTS Multiplexer



Encoder/Decoder H.264



> ENC 323

ENC-323 can operate as H.264 encoder or decoder.

As encoder, ENC-323 receives a Standard or High Definition SDI input signal, and processes it according to H.264 standard for video and AAC HEV2 and MPEG-2 LC standards for audio. Alternatively to SDI input, an internal SD/HD video bars generator is available along with an embedded test audio tone, to provide test or emergency video also when the input signal fails. ENC-323 produces an output MPEG-2 Transport Stream, containing the coded streams and SI/PSI tables PAT, PMT, SIT; the device allows the user to set PIDs of PMT, PCR, Audio and Video streams. The main audio channel carried by SDI is always MPEG-2 LC encoded while up to two selectable audio channels can be processed by the internal AAC-HE encoder at the same time.

As decoder, ENC-323 receives an input TS and processes it according to H.264 standard for video and MPEG-2 LC for audio. The output is transmitted via SDI, standard or high definition according to the encoded input.

VIDEO SPECIFICATIONS	
Video Compression and Bit-rate (CBR/VBR)	H.264 (ISO / IEC 14496-10), High-Level Profile 4.0 Half-duplex Codec
Video Processing	LookAhead multi-pass processing
	Scene-cut, fade/dissolve and skin tone detection
	Dynamic GOP management with adaptive I-picture and B-picture placement
	Automatic input format (1080i/p, 720p) detection and switching (SDI only)
	Inverse telecine
Video Input Filtering	Motion compensated temporal filter (MCTF)
	Horizontal filter
Aspect Ratios	4:3 and 16:9
	AFD and WSS control
SD Resolutions and Frame Rates	SD 480i, 576i
HD Resolutions and Frame Rates	HD 1080i (25Hz), 1080i(30Hz), 1080p (25Hz), 1080p (30Hz), 1080p (24Hz), 720p(60Hz).
HD Resolutions & frame Rates	1920 x 1080 x 59.94i/50i
	1440 x 1080 x 59.94i/50i
	1280 x 720 x 59.94p
	720 x 480 x 59.94i
	720 x 576 x 50i

AUDIO SPECIFICATIONS	
Standard Channels	1 stereo pair
Audio Formats	MPEG-1 Audio Layer 2, MPEG-2 AAC (LC profile), Linear PCM, Dolby® Digital (AC-3)1
Operating Modes Mono, stereo	Mono, Stereo
Encoding Bit-Rate	MPEG-4 AAC HEV2 (bitrate from 16 up to 48 Kbps), MPEG-2 LC (from 64 up to 384 Kbps)

PHYSICAL	
Dimensions	(W x H x D) 19" x 1.75" x 27" (1-RU) 48.26 cm x 4.45 cm x 68.69 cm
Weight	8,81 lbs. / 4 kg

INPUTS AND OUTPUTS	
INPUT	
Video Inputs	ASI. SDI (4x, BNC Connector)
	R Input: 75 Ohm
	V Input: 800 mVpp (500 to 1200 mVpp)
	Standard: CEI EN 50083-9 / SMPTE 259M,292M
	SPI (1x, DB25 Connector)
	R Input: 110 Ohm
	V Input: 385 mVdiff
OUTPUT	Standard:ANSI TIA/EIA-644
	ASI (4x, BNC Connector)
	R Input:75 Ohm
	V Input:800 mVpp (500 to 1200 mVpp)
	Standard: CEI EN 50083-9
HDMI N° Inputs: 1	Connector: HDMI Type A

SYSTEM MANAGEMENT	
Control Management GbE	Standalone web user interface
	N° Inputs: 1 Connector: RJ45
	Standard: IEEE 802.3
RS-232	N° Inputs: 1 Connector: DE-9 female

ENVIRONMENTAL	
Cooling	8 fans, temperature controlled air flow front to right side
Operating Temperature	+32° to +122° F 0° to +50° C
Storage Temperature	-4° to +176° F -20° to +80° C
Operating Humidity	< 95% non-condensing
Electromagnetic Compliance	FCC Part 15 Class A CE Mark (EN 55022 Class A and EN 50082-1:1997)
Safety	UL 1950 and cUL C22.2#950 EN 60950 ROHS Directive 2002/95/EC



Two channels multi-standard H.264 encoder tailored for the Mobile TV applications

Enc 326, is a 2 channels multi-standard H.264 encoder tailored for the Broadcasting Mobile TV services.

Developed for the next generation of digital video and audio end-equipment applications.

The encoder relies on a powerful hardware platform that features a best-in-class acquisition board, advanced pre-processing filters, statistical encoding, multiple codec support, multi-stream generation, and superior configuration and supervision capabilities. As a result, it is the solution of choice for all mobile TV applications.



> ENC 326

VIDEO SPECIFICATIONS	
Video Compression and Bit-rate (CBR/VBR)	MPEG-4 AVC BP@L1.3
Video Input Filtering	Horizontal Filter
Aspect Ratios	4:3 and 16:9
SD Resolutions & frame Rates	416 x 240p@29.97/30
	416 x 240p@25
	416 x 240p@24/23.98
	416 x 240p@12.5
	416 x 240p@12/11.98
	320 x 240p@29.97/30
Up/Down/Cross-Conversion	576i@25 to 416x240p, 320x240p
	480i@29.97/30 to 416x240p, 320x240p

AUDIO SPECIFICATIONS	
Standard Channels	1 stereo pair
Audio Formats	AAC-LC, AAC-HEv1, AAC-HEv2
Operating Modes Mono, stereo	Stereo
Encoding Bit-Rate	AAC-HEv2 16 to 64 Kbps

INPUTS AND OUTPUTS	
INPUT	
Video Inputs	ISMA: up to 2 Serial Digital(SMPTE259M) or CVBS (ITU PAL, NTSC)
Default Audio Inputs	One pair via SDI embedded or Balanced Audio
OUTPUT	ASI (only one A/V channel)
	R Input:75 Ohm
	V Input:800 mVpp (500 to 1200 mVpp)
	Standard: CEI EN 50083-9
	MPEGoverIP (only one A/V channel)

POWER	
Input Voltage Range	90-270 VAC PFC corrected power supply
Current	Nominal power 38 VA

ENVIRONMENTAL	
Cooling	8 fans, temperature controlled air flow front to right side
Operating Temperature	+32° to +122° F 0° to +50° C
Storage Temperature	-4° to +176° F -20° to +80° C
Operating Humidity	< 95% non-condensing
Electromagnetic Compliance	FCC Part 15 Class A CE Mark (EN 55022 Class A and EN 50082-1:1997)
Safety	UL 1950 and cUL C22.2#950 EN 60950 ROHS Directive 2002/95/EC

PHYSICAL	
Dimensions	(W x H x D) 19" x 1.75" x 27" (1-RU) 48.26 cm x 4.45 cm x 68.69 cm
Weight	8,81 lbs. / 4 kg

SYSTEM MANAGEMENT	
Control Management GbE	Standalone web user interface
	N° Inputs: 1 Connector: RJ45
	Standard: IEEE 802.3
RS-232	N° Inputs: 1 Connector: DE-9 female

Encoder HD/SD/1SEG, MPEG2/H.264



> ENC 333A

The ENC-333 is a high-definition system designed for real-time audio/video encoding for broadcast applications. This device is able to encode several HD and SD formats, providing high quality video, suitable for broadcast transmission. The video encoding technique, H.264 and MPEG-2, guarantees low output bit-rate with a flexible range that goes from 2 up to 25 Mbps. The audio stream is coded with high efficiency and quality, using: MPEG-1 Layer II, AAC-HE and AAC-LC or Dolby Digital Pro. ENC-333 encodes in SD or HD resolution the video input signal that it come from one of the inputs: SDI, HDMI, and Analog Video (Y, Cb, Cr), according to the coding standards, H.264 and MPEG-2. The ENC-333 includes not only video processing, but also stereo audio encoding in MPEG-1 Layer II (MP3), AAC HEv1, HEv2 and LC formats, Dolby Digital Professional. Video and audio elementary streams are multiplexed in an MPEG-2 Transport stream for output over an ASI link. A separate ASI input provides support for an external PSIP/SI data generator. Next to PAT and PMT, PSIP support includes MGT, TVCT and CVCT, while SI support includes NIT, SDT, CAT and TDT.

VIDEO SPECIFICATIONS	
Video Compression and Bit-rate (CBR/VBR)	MPEG-2 MP@ML 2 to 25 Mbps
	MPEG-2 MP@HL 4 to 25 Mbps
	MPEG-4 AVC MP@L3.0 0.5 to 25 Mbps
	MPEG-4 AVC HP@L4.1 4 to 25 Mbps
	MPEG-4 AVC BP@L1.2, L1.3 0.1 to 1 Mbps
Video Processing	LookAhead multi-pass processing
	Scene-cut, fade/dissolve and skin tone detection
	Dynamic GOP management with adaptive I-picture and B-picture placement
	Automatic input format (1080i/p, 720p) detection and switching (SDI only)
	Inverse telecine
Video Input Filtering	Motion compensated temporal filter (MCTF)
	Horizontal filter
	Input deblocking filter
Aspect Ratios	4:3 and 16:9
	AFD and WSS control
SD Resolutions and Frame Rates	576i@25, 480i@29.97 480i@30 x 720, 704, 640, 544, 528, 480, 352 pixels
HD Resolutions and Frame Rates	720p@23.97p, 24p, 25p, 29.97p, 30p, 50p, 59.94p 60p x 1280, 960, 640 pixels
	1080i@25, 29.97, 30 x 1920, 1440, 1280, 960 pixel
	1080p@23.97p, 24p, 25p, 29.97p, 30p x 1920, 1440, 1280, 960 pixel
Multiscreen Resolutions and Frame Rates	Built-in PIP (not enabled)
SD Resolutions & frame Rates	416x240p@25, 29.97 & 30
	352x288p@25
	320x240p@14.985, 15, 25, 29.97 & 30
	320x180p@14.985, 15, 25, 29.97 & 30
HD Resolutions & frame Rates	176x144p@25
	576x720i/p@25
	480x720i/p@29.97 & 30
	416x240p@25, 29.97 & 30
	352x288p@25
	320x240p@14.985, 15, 25, 29.97 & 30
	320x180p@14.985, 15, 25, 29.97 & 30
	176x144p@25

Up Down Cross-Conversion	1080i@25 to 576i@25 (HD to SD)
	1080i@29.97 & 30 to 480i@29.97 & 30 (HD to SD)
	1080i/p@25 to 352x288p, 416x240p, 320x240p, 328x180p @25 (HD to LD)
	1080i/p@29.97 & 30 to 416x240p, 320x240p, 328x180p @14.985, 29.97 & 30 (HD to SD)
	576i@25 to 352x288p, 416x240p, 320x240p, 328x180p @25 (SD to LD)
	480i@29.97 & 30 to 416x240p, 320x240p, 328x180p @14.985, 29.97 & 30 (SD to LD)

ANCILLARY DATA SPECIFICATIONS	
Closed Captioning	EIA608B field 1, 2, 1&2
	EIA708B
Ancillary Data and VBI	WSS, Video Index (SMPTE RP186), AFD/BAR data (SMPTE RP2016 1-3), AFS/BAR

AUDIO SPECIFICATIONS	
Standard Channels	1 x Stereo Pair (capable of up to 2 stereo pair in HD in version 3.0 and above)
Audio Formats	Consumer (AC3-CE, 2.0) native encoding
	Dolby Digital Surround (AC3 5.1), 2 x AAC (LC/HEV1/HEV2) Surround (5.1), 2 x MPEG1-LII, pass-through
Operating Modes Mono, stereo	Mono, Stereo
Encoding Bit-Rate	MPEG1 Audio Layer II 192 to 384 kbps
	Dolby Digital (AC-3) 56 to 448 kbps
	AAC-LC 32 to 384 kbps
	AAC-HEV1 32 to 192 kbps
	AAC-HEV2 32 to 96 kbps



INPUTS AND OUTPUTS	
INPUT	
Video Inputs	1 x Serial Digital (SMPTE 259M SD-SDI, SMPTE 292M HD-SDI), 1 x Component (YUV), 1 x HD-MIv1.3, 1 x CVBS (PAL, NTSC)
Default Audio Inputs	2 x SDI embedded, 2 x AES/EBU (AES3 750hm), 2 x HDMI, spdif, 2 x Stere Balanced Analog Audio
OUTPUT	
ASI	ASI
	R Input: 750hm
	V Input: 800mVpp (500 to 1200 mVpp)
	Standard: CEI EN 50083-9 (Not active for Dolby Digital Audio)
ASI over IP	Standard: SMPTE 2022 (FEC included)

SYSTEM MANAGEMENT	
Control Management GbE	Standalone web user interface
	N° Inputs: 1 Connector: RJ45
	Standard: IEEE 802.3
RS-232	N° Inputs: 1 Connector: DE-9 female

ENVIRONMENTAL	
Cooling	8 fans, temperature controlled air flow front to right side
Operating Temperature	+32° to +122° F 0° to +50° C
Storage Temperature	-4° to +176° F -20° to +80° C
Operating Humidity	< 95% non-condensing
Electromagnetic Compliance	FCC Part 15 Class A CE Mark (EN 55022 Class A and EN 50082-1:1997)
Safety	UL 1950 and cUL C22.2#950 EN 60950 ROHS Directive 2002/95/EC

PHYSICAL	
Dimensions	(W x H x D) 19" x 1.75" x 27" (1-RU) 48.26 cm x 4.45 cm x 68.69 cm
Weight	8,81 lbs. / 4 kg

Four Channel SD-Encoder MPEG2/H.264



> ENC 334

ENC 334 is the compact solution for your digital television head end. It provides up to 4 SD channel encoding capacity in order to quickly create a new line up or easily transcode existing analog channel line ups to new digital ones for either DVB-T, DVB-S, ATSC, IPTV, cable delivery. ENC 334 provides not only video processing, but also stereo audio encoding in MPEG-1, Layer II (MP3) and AAC (HE and LC) formats for each video channel. Video and audio elementary streams are multiplexed in an MPEG-2 Transport Stream for output over an ASI link. A separate ASI input provides support for an external PSIP/SI table data generator.

VIDEO SPECIFICATIONS	
Video Compression and Bit-rate (CBR/VBR)	MPEG-2 MP@ML 2 to 25 Mbps
	MPEG-4 AVC MP@L3.0 0.5 to 25 Mbps
	MPEG-4 AVC BP@L1.2, L1.3 0.1 to 1 Mbps
Video Processing	LookAhead multi-pass processing
	Scene-cut, fade/dissolve and skin tone detection
	Dynamic GOP management with adaptive I-picture and B-picture placement
	Automatic input format (1080i/p, 720p) detection and switching (SDI only)
	Inverse telecine
Video Input Filtering	Motion compensated temporal filter (MCTF)
	Horizontal filter
	Input deblocking filter
Aspect Ratios	4:3 and 16:9
	AFD and WSS control
SD Resolutions and Frame Rates	576i@25, 480i@29.97 480i@30 x 720, 704, 640, 544, 528, 480, 352 pixels
Multiscreen Resolutions and Frame Rates	Built-in PIP (not enabled)
SD Resolutions & frame Rates	416x240p@25, 29.97 & 30
	352x288p@25
	320x240p@14.985, 15, 25, 29.97 & 30
	320x180p@14.985, 15, 25, 29.97 & 30
	176x144p@25
Up/Down/Cross-Conversion	576i@25 to 352x288p, 416x240p, 320x240p, 328x180p @25 (SD to LD)
	480i@29.97 & 30 to 416x240p, 320x240p, 328x180p @14.985, 29.97 & 30 (SD to LD)
Up/Down/Cross-Conversion	1080i@25 to 576i@25 (HD to SD)
	1080i@29.97 & 30 to 480i@29.97 & 30 (HD to SD)
	1080i/p@25 to 352x288p, 416x240p, 320x240p, 328x180p @25 (HD to LD)
	1080i/p@29.97 & 30 to 416x240p, 320x240p, 328x180p @14.985, 29.97 & 30 (HD to SD)
	576i@25 to 352x288p, 416x240p, 320x240p, 328x180p @25 (SD to LD)
	480i@29.97 & 30 to 416x240p, 320x240p, 328x180p @14.985, 29.97 & 30 (SD to LD)
ANCILLARY DATA SPECIFICATIONS	
Closed Captioning	EIA608B field 1, 2, 1&2
	EIA708B
Ancillary Data and VBI	AFS/BAR, WSS

PHYSICAL	
Dimensions	(W x H x D) 19" x 1.75" x 27" (1-RU) 48.26 cm x 4.45 cm x 68.69 cm
Weight	8,81 lbs. / 4 kg

AUDIO SPECIFICATIONS	
Standard Channels	1 stereo pair
Audio Formats	MPEG-1 Layer II, AAC-LC, AAC-HEv1, AAC-HEv2 native encoding
	Dolby Digital Pro (AC3 2.0 & 5.1), AAC-LC/HEv1&2 Surround (5.1) pass-through
Operating Modes Mono, stereo	Mono, Stereo
Encoding Bit-Rate	MPEG Audio Layer II 192 to 384 kbps
	AAC-LC 32 to 384 kbps
	AAC-HEv1 32 to 192 kbps
	AAC-HEv2 32 to 96 kbps

INPUTS AND OUTPUTS	
INPUT	
Video Inputs	four Composite (CVBS), Component(YUV) inputs
Default Audio Inputs	four stereo analog audio inputs
OUTPUT	ASI
	R Input:75 Ohm
	V Input:800 mVpp (500 to 1200 mVpp)
	Standard: CEI EN 50083-9

SYSTEM MANAGEMENT	
Control Management GbE	Standalone web user interface
	N° Inputs: 1 Connector: RJ45 Standard: IEEE 802.3
RS-232	N° Inputs: 1 Connector: DE-9 female

ENVIRONMENTAL	
Cooling	8 fans, temperature controlled air flow front to right side
Operating Temperature	+32° to +122° F 0° to +50° C
Storage Temperature	-4° to +176° F -20° to +80° C
Operating Humidity	< 95% non-condensing
Electromagnetic Compliance	FCC Part 15 Class A CE Mark (EN 55022 Class A and EN 50082-1:1997)
Safety	UL 1950 and cUL C22.2#950 EN 60950 ROHS Directive 2002/95/EC



Professional Satellite Receiver

Description

The PRO RX S2 is a DVB-S/S2 receiver with up to three ASI outputs designed for the primary distribution of mobile and/or terrestrial television over satellite. Operating in compliance with the DVB-S2 standard, the PRO RX S2 is capable of demodulating multiple MPEG transport stream in multi-stream mode: once received the input multi-stream, the transport streams are separated again based on their DVB-S2 Input Stream Identifier (ISI), then the desired services are descrambled by a CAM (Smart Card – common interface) modules with commonly adopted CAS in the market. With ASI and IP interfaces for input and output, PRO_RX_SAT 2 can be integrated into any head end systems for content delivery and re-distribution. (Professional Satellite Receiver, DVB S2 Professional Receiver).



PRO RX S2



PRO RX S2 In 1+1 configuration

Main Features

RF Input

Connector used as input to the systems

- N° input: 1 for each receiver board
- Connector type: LNB (female)
- R input: 75 Ω
- V input: 1.75 V
- Frequency: 950 to 2150 MHz
- DVB-S (ETSI EN 300 421)
- DVB-S2 (ETSI EN 302 307)

1 x Common Interface (for each receiver)

Connector used as input CAM

- Connector type: PCMCIA
- DVB-CI EN 50221-1997

1 x FastEthernet (Management)

- Connector: RJ45
- Standard supported: IEEE 802.3

3 x ASI Output (same content) / 6 x ASI Output (1+1 or 2+0 configuration)

- TS Descrambled (TSD)
- Connector type: BNC
- Input: 75 ohm, 800 mVpp (500 to 1200mVpp)
- MPEG-2 TS ISO/IEC 13818-1
- CEI EN 50083-9,

Management of the devices is made through:

- Java GUI on Ethernet connection.
- SNMP agent.

Power Supply

- Dual Power Supply (only in 1+1 or 2+0 configuration)
- 110/220V AC Auto Switching
- 48V DC (Option on Request)

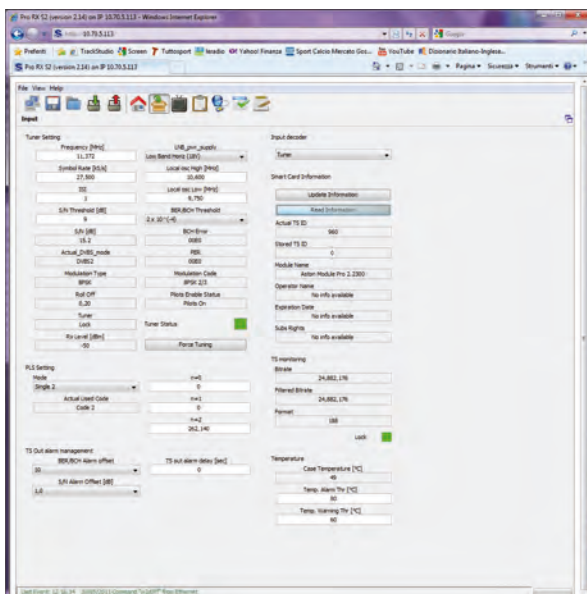

JAVA INTERFACE



SATELLITE RECEIVER DESCRIPTION

Tuner	
Frequency range	950 to 2150 MHz
Supported Standard	DVB-S EN 300 421 v1.1.2: Digital Video Broadcasting (DVB); Framing structure, channel coding and modulation for 11/12 GHz satellite services DVB-S2 EN 302 307 v1.1.2: Digital Video Broadcasting (DVB); Second generation framing structure, channel coding and modulation systems for Broadcasting, Interactive Services, News Gathering and other broadband Satellite applications
Input Sat RF	
Tuning Setting	Frequency
	Symbol Rate
	ISI
	S/N Threshold
	LNB_pwr_supply
	Local osc Low
	BER/BCH Threshold
Force Tuning	
Monitoring	Actual_DVBS_mode
	Modulation Code
	Modulation Type
	Pilots Enable Status
	Rx Level [dBm]
	S/N [dB]
	Tuner Lock Flag
	Error Values
DVB-S Demodulator Features	
Setting Demodulator	QPSK
	FEC: 1/2, 2/3, 3/4, 5/6, 7/8
	Broadcast operating range 45 MSymbols/s
Automatic configurations monitoring	CCM
	Modulation type
	Filter roll-off
	Pilot presence (on/off)
	Long frames only
	Forward error correction
	Viterbi and Reed-Solomon dual decoder
Error monitoring	
Demodulator Features DVB- S2	
Setting Demodulator	FEC QPSK: 1/4, 1/3, 2/5, 1/2, 3/5, 2/3, 3/4, 4/5, 5/6, 8/9, 9/10
	B. FEC 8PSK: 3/5, 2/3, 3/4, 5/6, 8/9, 9/10
	FEC 16APSK: 2/3, 3/4, 4/5, 5/6, 8/9, 9/10
	FEC 32APSK: 3/4, 4/5, 5/6, 8/9, 9/10
	FECFRAME: both normal and short
	Broadcast operating range from 1 to 67 MSymb/s
	CCM, VCM and ACM
Automatic configurations monitoring	Modulation type
	Filter roll-off
	Pilot presence (on/off)
	Long frames only
	Forward error correction
	LDPC + BCH dual decoder
	Error monitoring

Physical layer scrambling	
Adjustable parameters	Mode
	First Physical Layer Scrambling sequence
	Second Physical Layer Scrambling sequence
Monitoring	Third Physical Layer Scrambling sequence
DVB descrambler	Actual Used Code
	DVB
	TS0 (TS Descrambled) output interface
	Descrambler - max 12 Services
Cam Reader	Encryption systems supported: all mayors CA suppliers
	CAM supported: all mayors CA suppliers
	Smart Card Information
	Read Information
	Actual TS ID
	Stored TS ID
	Module Name
Services Informations	Operator Name
	Expiration Date
	Subs Rights
	Scrambled and not scrambled services
	Information
	Service Name
	Service ID
	Video PID
	Audio PID
	PCR PID
TTX PID	
TS Out	Output TS Monitoring
	Bitrate
	Filtered Bitrate
	Format
	Lock
BB Frame and T2 MI out supported	

ALARM MANAGEMENT

Tuner unlocked	
CAM presence	
Smart Card presence	
Rights Absence	
TS Id changed	
Decrypt error	
Hardware	
Temperature High	
Temperature Warning	
S/N Alarm	
BER/PER Alarm	
PS1 Voltage low	
PS2 Voltage low	
32 bit alarms available	
Alarm Matrix Management	Alarm notification
	Alarm notification via Java GUI
	LED alarm on the front panel
	Enable logging event alarm
	SNMP trap
Event Log	Disable Mask TS out for alarm
	SNMP v1

Professional Satellite Receiver



PRO RX S2 with Decoder

Description

The PRO RX S2 is a DVB-S/S2 receiver with up to three ASI outputs designed for the primary distribution of mobile and/or terrestrial television over satellite. Operating in compliance with the DVB-S2 standard, the PRO RX S2 is capable of demodulating multiple MPEG transport stream in multi-stream mode: once received the input multi-stream, the transport streams are separated again based on their DVB-S2 Input Stream Identifier (ISI), then the desired services are descrambled by a CAM (Smart Card – common interface) modules with commonly adopted CAS in the market. With ASI and IP interfaces for input and output, PRO_RX_SAT 2 can be integrated into any head end systems for content delivery and re-distribution. (Professional Satellite Receiver, DVB S2 Professional Receiver).

Audio and Video services are decoded and available on several interface.

Main Features

RF Input

Connector used as input to the systems

- N° input: 1 for each receiver board
- Connector type: LNB (female)
- R input: 75 Ω
- V input: 1.75 V
- Frequency: 950 to 2150 MHz
- DVB-S (ETSI EN 300 421)
- DVB-S2 (ETSI EN 302 307)

1 x Common Interface (for each receiver)

Connector used as input CAM

- Connector type: PCMCIA
- DVB-CI EN 50221-1997
- BISS descrambling – up to full TS
- CA Methods : MultiCrypt, SimulCrypt

1 x FastEthernet (Management)

- Connector: RJ45
- Standard supported: IEEE 802.3

3 x ASI Output (same content)

- TS Descrambled (TSD)
- Connector type: BNC
- Input: 75 ohm, 800 mVpp (500 to 1200mVpp)
- MPEG-2 TS ISO/IEC 13818-1
- CEI EN 50083-9,

Management of the devices is made through:

- Java GUI on Ethernet connection.
- SNMP agent.

Power Supply

- Dual Power Supply (only in 1+1 or 2+0 configuration)
- 110/220V AC Auto Switching
- 48V DC (Option on Request)

Audio/Video decoder section description:

Video standard supported:

- H.264/AVC: Level 4.1 high profile video decoder
- MPEG-2: MP@HL

HD video resolution supported:

- 1920x1080i30
- 1920x1080i25
- 1280x720p60
- 1280x720p50

SD video resolution supported:

- 720x576i25 compliant PAL-BG
- 720x576i29 compliant PAL-M
- 720x480i compliant NTSC

Audio standard supported:

- MPEG-2, layer I
- MPEG-2, layer II

Decoder Output:

1 x SDI-SD Output

- Connector: BNC
- Input: 75 Ohm, 800mVpp (500 to 1200 mVpp)
- Standard: SMPTE 259M,292M

1 x RGB-SD (R,G,B) Outputs

- Connector: RCA

1 x CVBS-SD Output

- Composite Video Blanking Sync
- Connector: RCA

1x HDMI-HD/SD Output

- Connectors: HDMI Type A

1 x YUV-HD (Y,U,V) Outputs

- Connector: XLR

1 x YPbPr (Y, U, V) (HD)

- Connector: RCA

1 x Audio out (Left e Right)

- Connector: mini XLR



SATELLITE RECEIVER DESCRIPTION

Tuner	
Frequency range	950 to 2150 MHz
Supported Standard	DVB-S EN 300 421 v1.1.2: Digital Video Broadcasting (DVB); Framing structure, channelcoding and modulation for 11/12 GHz satellite services
	DVB-S2 EN 302 307 v1.1.2: Digital Video Broadcasting (DVB); Second generation framingstructure, channel coding and modulation systems for Broadcasting, Interactive Services, News Gathering and other broadband Satellite applications
Input Sat RF	
Tuning Setting	Frequency
	Symbol Rate
	ISI
	S/N Threshold
	LNB_pwr_supply
	Local osc Low
	BER/BCH Threshold
Monitoring	Force Tuning
	Actual_DVBS_mode
	Modulation Code
	Modulation Type
	Pilots Enable Status
	Rx Level [dBm]
	S/N [dB]
DVB-S Demodulator Features	
Setting Demodulator	QPSK
	FEC: 1/2, 2/3, 3/4, 5/6, 7/8
	Broadcast operating range 45 MSymbols/s
Automatic configurations monitoring	CCM
	Modulation type
	Filter roll-off
	Pilot presence (on/off)
	Long frames only
	Forward error correction
Demodulator Features DVB- S2	
Setting Demodulator	FEC QPSK: 1/4, 1/3, 2/5, 1/2, 3/5, 2/3,3/4, 4/5, 5/6, 8/9, 9/10
	B. FEC 8PSK: 3/5, 2/3, 3/4, 5/6, 8/9,9/10
	FEC 16APSK: 2/3, 3/4, 4/5, 5/6, 8/9,9/10
	FEC 32APSK: 3/4, 4/5, 5/6, 8/9, 9/10
	FECFRAME: both normal and short
	Broadcast operating range from 1 to 67 MSymb/s
	CCM, VCM and ACM
Automatic configurations monitoring	Modulation type
	Filter roll-off
	Pilot presence (on/off)
	Long frames only
	Forward error correction
	LDPC + BCH dual decoder
Error monitoring	

Physical layer scrambling	
Adjustable parameters	Mode
	First Physical Layer Scrambling sequence
	Second Physical Layer Scrambling sequence
Monitoring	Third Physical Layer Scrambling sequence
	Actual Used Code
DVB descrambler	DVB
	TSD (TS Descrambled) output interface
	Descrambler - max 12 Services
	Encryption systems supported: all mayors CA suppliers
Cam Reader	CAM supported: all mayors CA suppliers
	Smart Card Information
	Read Information
	Actual TS ID
	Stored TS ID
	Module Name
	Operator Name
Services Informations	Expiration Date
	Subs Rights
	Scrambled and not scrambled services
	Information
	Service Name
	Service ID
	Video PID
	Audio PID
	PCR PID
	TTX PID
TS Out	Output TS Monitoring
	Bitrate
	Filtered Bitrate
	Format
	Lock
	BB Frame and T2 MI out supported

ALARM MANAGMENT

Tuner unlocked	
CAM presence	
Smart Card presence	
Rights Absence	
TS Id changed	
Decrypt error	
Hardware	
Temperature High	
Temperature Warning	
S/N Alarm	
BER/PER Alarm	
PS1 Voltage low	
PS2 Voltage low	
32 bit alarms available	
Alarm Matrix Management	Alarm notification
	Alarm notification via Java GUI
	LED alarm on the front panel
	Enable logging event alarm
	SNMP trap
Event Log	Disable Mask TS out for alarm
	SNMP v1

HARDWARE CONNECTORS

RF input to the device	
N° input	1
Connector type	LNB (female)
R input	75 Ω
V input	16 dBuV to 115 dBuV
Frequency	42 to 866 MHz
Smart-card input	
N° input	1
Connector type	PCMCIA
N° connectors	1
Connector	RJ45
Standard supported	IEEE 802.3
TS output from the system	
N° Output	1
Connector type	MCX
R input	75 Ω
V input	800 mVpp (500 to 1200mVpp)
Standard	CEI EN 50083-9

DECODER FEATURES

SD-SDI-OUT	Connector Used as output to the systems
	N° Outputs: 1
	Connector: BNC
	R Input: 75 Ohm
	V Input: 800 mVpp (500 to 1200 mVpp)
RGB -SD-OUT	Standard: SMPTE 259M,292M
	Connector Used as output to the systems
	N° Outputs: 3 (R, G, B)
	Connector: RCA
	R Input
CVBS -SD-OUT	V Input
	Standard
	Connector Used as output to the systems
	N° Outputs: 1
	Composite Video Blanking Sync
HDMI (HD/SD) OUT	Connector: RCA
	R Input
	V Input
	Standard
	Connector Used as output to the systems
YUV (HD)	N° Outputs: 1
	Connectors: HDMI Type A
	Connector Used as output to the systems
	N° Inputs: 3 (Y, U, V)
	Connector: RCA
Audio (Out)	R Input: -
	V Input: -
	Standard: -
	Audio connector
	Connettori audio
	N° Outputs: 2 (Usati per Left e Right)
	Connector: 2 pin su scheda
	R Input:V Input
	Standard

Power Supply

Dual Power Supply (only in 1+1 or 2+0 configuration)
110/220V AC Autoswitching
48V DC



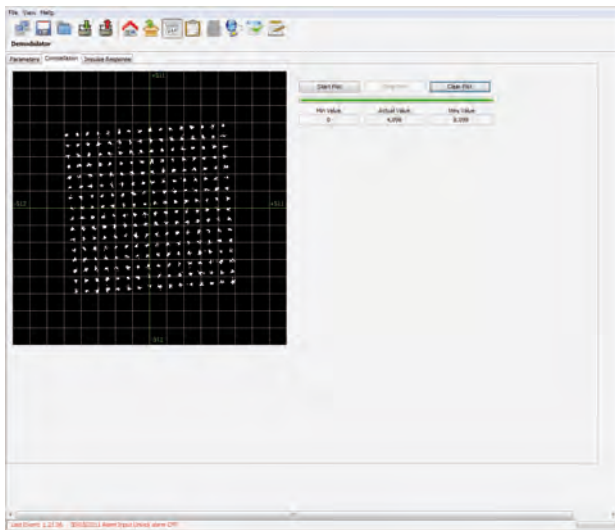

Demodulator - Constellation

The screenshot shows the 'T2 Parameters' configuration window. It contains two main sections: 'T2' and 'PTP Group'. Each section has a grid of parameters with their current values.

T2			
Input Stream Type	LL_CDD	CELL_ID	0
TS	84-QAM		0
EXT_BIT	LL_CDD	NETWORK_ID	0
Extended Carrier Mode	LS		0
S1_Freq	LL_FRC_TYPE	T2_SYSTEM_ID	0
T2_SISO	LSFC_0M		0
PTP_0m	LL_Prot_0m	Page_0m	0
0M	06.30400		0
LL_Protion_Prot	LL_Prot_0m_0m	LL_Prot_0m_0m	0
Disabled	20.84048	Not present	0
GUARD_INTERVAL	PLDT_PATTERN	NUM_OF	0
LS2B	PTT		0
PAPR	TS_AVAILABILITY	CLASSTYP_0m	0
NO_PAPR	0		0
LS_0M	Num_Data_0m	NUM_T2_PLANE	2
NO_0M	0		0
PTP Group			
PTP_ID	PTP_FRC_TYPE	PTP_ID	PTP_FRC_TYPE
0	64-QAM	0	64-QAM
PTP_TYPE	PTP_NUM_BLOCKS_MAX	PTP_TYPE	PTP_NUM_BLOCKS_MAX
DATA_PTP_Type 1	300	Common-PTP	0
PTP_PAYLOAD_TYPE	FRAME_INTERVAL	PTP_PAYLOAD_TYPE	FRAME_INTERVAL
TS	0	0	0
PTP_FLAG	TIME_S_LENGTH	PTP_FLAG	TIME_S_LENGTH
0	0	0	0
PTPOT_0m	TIME_S_TYPE	PTPOT_0m	TIME_S_TYPE
0	Single T2 Plane on P	0	0
PTPOT_PLANE_0m	IN-BAND_FLAG	PTPOT_PLANE_0m	IN-BAND_FLAG
0	Time sig. is not carried	0	Time sig. is not carried
PTP_GROUP_ID	PTP_ID	PTP_GROUP_ID	PTP_ID
1	28-QAM	0	0
PTP_CODE	PTP_ROTATION	PTP_CODE	PTP_ROTATION
LS	Rotation is used	LS	Rotation is not used

Demodulator - T2 parameters

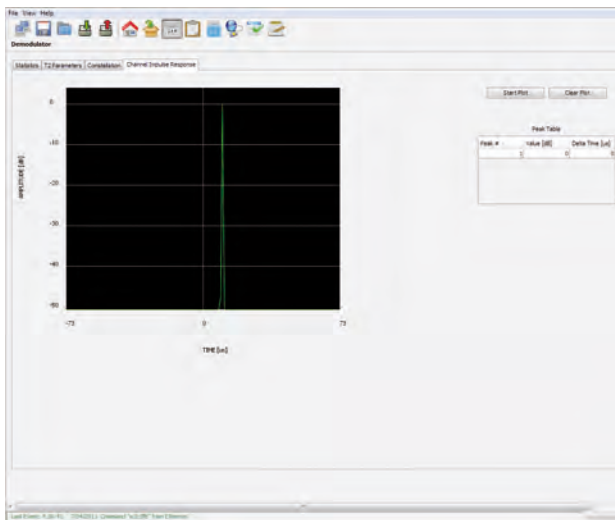

Demodulator - Impulse Response

The screenshot shows the 'Input' section of the Demodulator. It is divided into 'Tuner Monitoring' and 'Smart Card Information'.

Tuner Monitoring: Shows 'Rx Level' at 4.00m, 'Quality' at 89, 'S/N [dB]' at 24.969, 'MER [dB]' at 21.215, and 'Spectrum Sense' at Normal.

Smart Card Information: Shows 'Actual TS ID' as 960, 'Stored TS ID' as 960, 'Module Name' as 'Action Module Pro 2.1800', 'Operator Name' as 'HECQUET', and 'Expiration Date' as '01/10/2011'.

Input

The screenshot shows the 'Statistics' configuration window. It contains two columns of parameters for 'T2' and 'PTP'.

T2		PTP	
Pre-Mch BER [1e-7]	2.394	CAI [dB]	0
Pre-ech BER [1e-7]	0	Pre-ech RES [1e-7]	0
Post-ech BER	0	Pre-DS BER [1e-7]	0
Current LDFC Decisions	1	ES Error	0
S1_Freq	0	Constellation	0
T2_SISO	0	Modulation	0
PTP_0m	0	Modulation	0
EXT_BIT	0	HP-FRC	0
Normal Carrier Mode	0	LP-FRC	0
GUARD_INTERVAL	0	Guard Time	0
LS	0		0
PAPR	0		0
NO_PAPR	0		0
PLDT_PATTERN	0		0
PTT	0		0
CELL_ID	0	Cell ID	0
NETWORK_ID	0		0
T2_SYSTEM_ID	0		0

Demodulator - Statistics

The screenshot shows the 'Service List' window. It contains a table with columns for 'Service Name', 'Service ID', 'Video PID', 'Audio Info', 'PCR PID', and 'TTV PID'.

Service Name	Service ID	Video PID	Audio Info	PCR PID	TTV PID
Service 1	8001	0	0	8191	0
Service 2	8002	0	0	8191	0
Service 3	8003	0	0	8191	0
Service 4	8004	0	0	8191	0
Service 5	8005	0	0	8191	0
Service 6	8006	0	0	8191	0
Service 7	8007	0	0	8191	0
Service 8	8008	0	0	8191	0
Radio v1	8104	0	0	8191	0
Radio v2	8104	0	0	8191	0
Radio v3	8104	0	0	8191	0
Radio v4	8104	0	0	8191	0
Radio v5	8104	0	0	8191	0
Radio v6	8104	0	0	8191	0
Radio v7	8104	0	0	8191	0
Radio v8	8104	0	0	8191	0
Radio v9	8104	0	0	8191	0
Radio v10	8104	0	0	8191	0
Radio v11	8104	0	0	8191	0
Radio v12	8104	0	0	8191	0
Radio v13	8104	0	0	8191	0
Radio v14	8104	0	0	8191	0
Radio v15	8104	0	0	8191	0
Radio v16	8104	0	0	8191	0
Radio v17	8104	0	0	8191	0
Radio v18	8104	0	0	8191	0
Radio v19	8104	0	0	8191	0
Radio v20	8104	0	0	8191	0
Radio v21	8104	0	0	8191	0
Radio v22	8104	0	0	8191	0
Radio v23	8104	0	0	8191	0
Radio v24	8104	0	0	8191	0
Radio v25	8104	0	0	8191	0
Radio v26	8104	0	0	8191	0
Radio v27	8104	0	0	8191	0
Radio v28	8104	0	0	8191	0
Radio v29	8104	0	0	8191	0
Radio v30	8104	0	0	8191	0
Radio v31	8104	0	0	8191	0
Radio v32	8104	0	0	8191	0
Radio v33	8104	0	0	8191	0
Radio v34	8104	0	0	8191	0
Radio v35	8104	0	0	8191	0
Radio v36	8104	0	0	8191	0
Radio v37	8104	0	0	8191	0
Radio v38	8104	0	0	8191	0
Radio v39	8104	0	0	8191	0
Radio v40	8104	0	0	8191	0
Radio v41	8104	0	0	8191	0
Radio v42	8104	0	0	8191	0
Radio v43	8104	0	0	8191	0
Radio v44	8104	0	0	8191	0
Radio v45	8104	0	0	8191	0
Radio v46	8104	0	0	8191	0
Radio v47	8104	0	0	8191	0
Radio v48	8104	0	0	8191	0
Radio v49	8104	0	0	8191	0
Radio v50	8104	0	0	8191	0
Radio v51	8104	0	0	8191	0
Radio v52	8104	0	0	8191	0
Radio v53	8104	0	0	8191	0
Radio v54	8104	0	0	8191	0
Radio v55	8104	0	0	8191	0
Radio v56	8104	0	0	8191	0
Radio v57	8104	0	0	8191	0
Radio v58	8104	0	0	8191	0
Radio v59	8104	0	0	8191	0
Radio v60	8104	0	0	8191	0
Radio v61	8104	0	0	8191	0
Radio v62	8104	0	0	8191	0
Radio v63	8104	0	0	8191	0
Radio v64	8104	0	0	8191	0
Radio v65	8104	0	0	8191	0
Radio v66	8104	0	0	8191	0
Radio v67	8104	0	0	8191	0
Radio v68	8104	0	0	8191	0
Radio v69	8104	0	0	8191	0
Radio v70	8104	0	0	8191	0
Radio v71	8104	0	0	8191	0
Radio v72	8104	0	0	8191	0
Radio v73	8104	0	0	8191	0
Radio v74	8104	0	0	8191	0
Radio v75	8104	0	0	8191	0
Radio v76	8104	0	0	8191	0
Radio v77	8104	0	0	8191	0
Radio v78	8104	0	0	8191	0
Radio v79	8104	0	0	8191	0
Radio v80	8104	0	0	8191	0
Radio v81	8104	0	0	8191	0
Radio v82	8104	0	0	8191	0
Radio v83	8104	0	0	8191	0
Radio v84	8104	0	0	8191	0
Radio v85	8104	0	0	8191	0
Radio v86	8104	0	0	8191	0
Radio v87	8104	0	0	8191	0
Radio v88	8104	0	0	8191	0
Radio v89	8104	0	0	8191	0
Radio v90	8104	0	0	8191	0
Radio v91	8104	0	0	8191	0
Radio v92	8104	0	0	8191	0
Radio v93	8104	0	0	8191	0
Radio v94	8104	0	0	8191	0
Radio v95	8104	0	0	8191	0
Radio v96	8104	0	0	8191	0
Radio v97	8104	0	0	8191	0
Radio v98	8104	0	0	8191	0
Radio v99	8104	0	0	8191	0
Radio v100	8104	0	0	8191	0

Service list

Headend Central Manager



> EPC Server

The SPC server can manage the DVB-T headend and generate an EPG for every kind of architecture, including small or large headends.

SPC Server with XBT 525, when combined are the complete solution for the DVB-T Headend Management.

SPC Features:

EPG Generation

SPC supports different inputs for the EPG generation: such as XML files or Plain Text Files. Content provisioning can be made manually or via file transfer protocol (FTP) based using periodic transfers. SPC comes with a full-featured EPG editor.

Multiplexer management

SPC allows to easily configure one or more XBT525 multiplexer. SPC includes automatic device discovering and inventory management, an automatic PID filtering, complete MUX management and SI/PSI signalling/generation. SPC is also equipped with an alarm device monitoring.

SPC Versions features

- EPG Server standalone
- Integrated with every multiplexer
- Ethernet output
- SI/PSI generation (PAT, PMT, NIT, SDT, TDT, TOT, EIT P/F and EIT Schedule)
- NTP enabled
- EPG Server Management platform
- Integrated with XBT525
- Full XBT525 management, monitoring and trending
- ASI/Ethernet output
- SI/PSI generation (PAT, PMT, NIT, SDT, TDT, TOT, EIT P/F and EIT Schedule)
- PID filtering and remapping
- NTP enabled

Overall key features

- Easy interfacing with program guide content providers
- Real-time EPG updates
- Flexible and scalable hardware/software architecture
- Superior management of PSI tables including EIT P/F and schedule
- XML-enabled to facilitate connectivity
- User-rights management
- Ethernet and/or ASI output capabilities
- User-friendly graphical user interface (Web/HTML) for easy configuration and supervision

EPG Related features

- DVB-SI (ETS 300 468) standard compliant
- SI tables support (PAT, PMT, NIT, SDT, TDT, TOT, EIT P/F, and Schedule)
- SI tables modification and filtering
- EIT P/F transition using the server clock
- Multi-language support
- User-rights management



- NTP client
- Web configuration and supervision

I/O specifications

Input

- XML files
- CVS files
- FTP file transfer
- Periodic file transfer
- Interactive editing

Output

- ASI output interface (with XBT525)
- Ethernet output (both version)

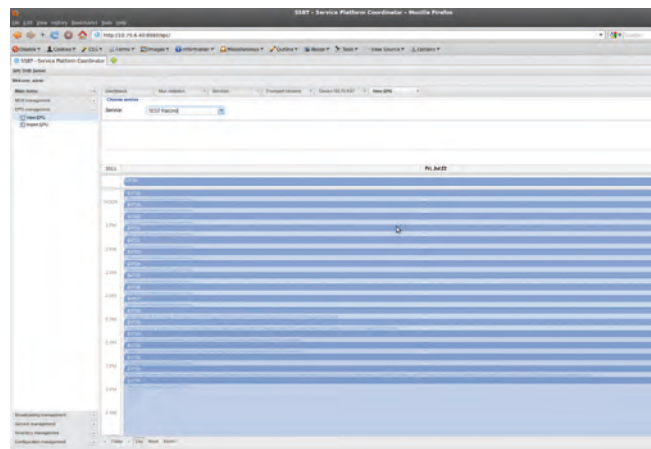
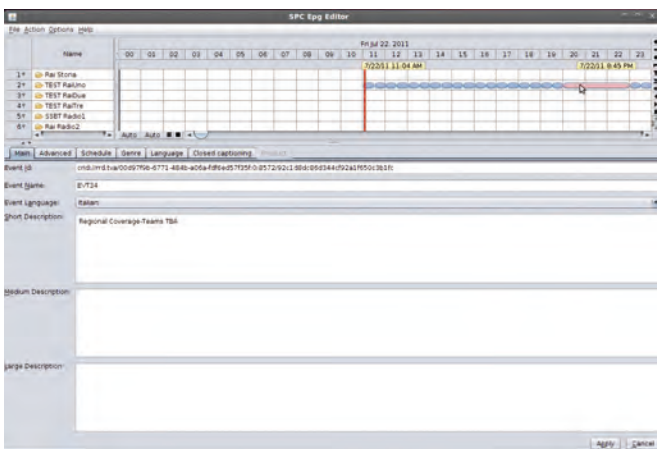
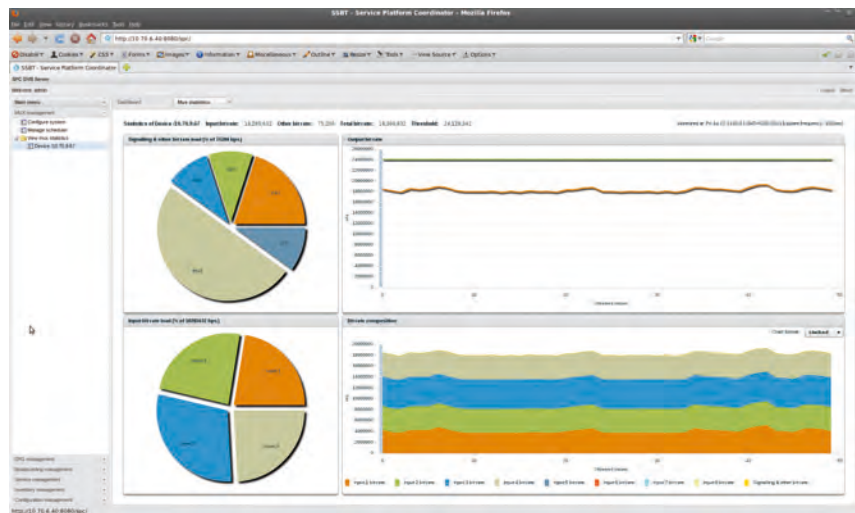
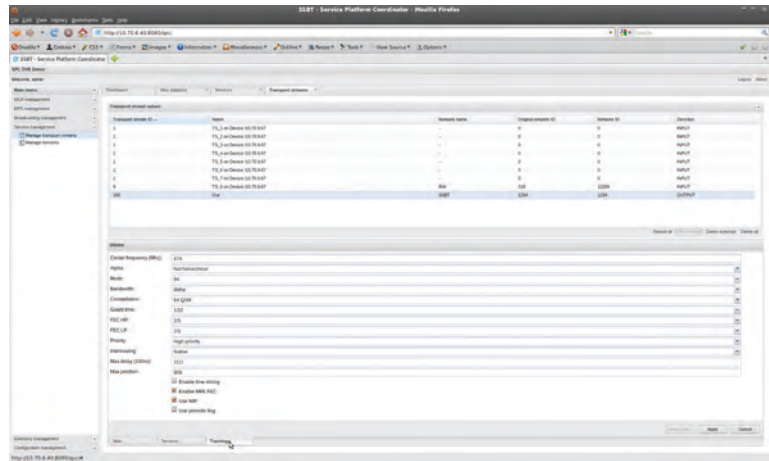

Service Platform GUI Screenshots

MFP Multiplexer (Metric Feed Packets)

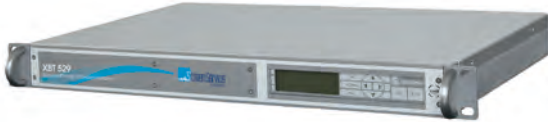

> XBT 538

Description

XBT538 MFP Multiplexer is the head end main building block of the powerful SSBT regionalization system.

XBT538 MFP Multiplexer performs the following basic functions:

- GPS receiver capable of synchronizing internal time generators
- Metric Feed Packets generation
- Multiplexing of Metric Feed Packets and 4 transport streams selected between 11 physical inputs with PCR re-stamping
- Perform network adaptation to the final Fat Pipe output transport stream bit rate

Inputs to multiplexer are:

- 8 ASI transport streams
- 1 SPI connector for multiplexer extension
- 2 RTP clients for RTP/UDP encapsulated Transport Streams on 2 sockets on single ethernet port

Outputs from multiplexer are:

- 4 ASI transport streams carrying all the same MFP transport stream
- 1 RTP/UDP Server carrying encapsulated Transport stream
- SPI output for system extension
- As any multiplexer of the XBT family, it has built-in:
 - Web server to dispatch a Java applet for interactive management
 - Java applet tested on most popular browser
 - Java applet downloadable for local execution
 - SNMP server for remote control
 - Internal file system accessible via TCP/IP and TFTP protocols for easy remote upgrade
 - Ultra fast storage are for event system storage
 - Telnet server for access via character based terminals
 - Geographical coordinates available
 - Battery powered local time clock automatically synchronized to UTC
 - 8 trap address for automatic alarm/monitoring

Main Features

Remote control interfaces

RS-232

- Dedicated DB9 connector
- Data only
- Also available on remote control DB25 connector
- 230400 bps

Relays

- 4 relays for alarm/info
- NO & NC contacts at connector
- Available on remote control DB25 connector

Opto couplers

- 4 opto couplers for command
- Internal floating current generator
- Common anode
- 2 mA max on current

Functions

- Default: 1 relay alarm/ok
- Option "N1": use relay and opto for SSBT N+1 system



PHYSICAL	
Rack frame	1U
Size	(W) 484 mm x (H) 45 mm x (D) 346 mm
Weight	4kg

POWER SUPPLY	
90-270 VAC PFC corrected power supply	
Nominal power 38 VA	
Power factor: 0.95	
Max inrush current 15A	
M6 screw for extra ground connection	
Power cord	Default - Italy
	Option "UK" - UK standard
	Option "DIN" - Germany and central Europe DIN connector
	Option "US" - US standard

ASI INPUTS	
EN 500083-9 compliant	
BNC connectors 75 ohm	
Maximum bit rate 155 Mbit	

SPI INPUT	
EN 500083-9 compliant	
DB25 female connector	
Maximum bit rate 27 Mbytes	

ETHERNET CONNECTION	
10/100/1000 Mbit Ethernet connector	
1 IP address for web server, management, SNMP server, Telnet, TFTP and remote update	
1 IP address for RTP/UDP server	
1 IP address for RTP/UDP client	
RTP protocol: ProMpeg cop3 with no FEC packet processing/generation	

GPS INPUT	
TNC connector 50 ohm	
Phantom power 3 Volt 50 mA short circuit protected	
GPS L1	
12 channel simultaneous operation	
45 s typical cold start TTF	
38 s typical warm start TTF	
5 s typical hot start TTF	
<0.5 s reacquisition	
Sensitivity Acquisition/Tracking -185dBW / -185dBW	
30ns rms accuracy, <10ns resolution	

ASI OUTPUT	
EN 500083-9 compliant	
BNC connectors 75 ohm	
Maximum bit rate as per DVB-T standard	

SPI OUTPUT	
EN 500083-9 compliant	
DB25 female connector	
Maximum bit rate as per DVB-T standard	

FRONT PANEL	
4 x 20 alpha displays	
8 button navigation	
Basic setup and status	

REFERENCE INPUTS	
10MHz	SMB connector
	1Vpp sine
	50 ohm terminated
	AC coupled Option "HIZ" available
1 sec PPS	SMB connector
	0.4 VIL
	1.7 VIH
	Dc coupled
	50 ohm terminated Option "HIZ" available

REFERENCE OUTPUTS	
10MHz	SMB connector
	1Vpp sine
	50 ohm
	DC coupled
1 sec PPS	SMB connector
	0.2 VOL @ 64 mA IOL
	2.2 VOH @ 64 mA IOH
	Dc coupled
	50 ohm capable

SOFTWARE	
Java applet requires Java 6 Version 13 or more recent	
Java applet tested on Safari, Internet Explorer, Mozilla	
Browser will download automatically suitable version of Java if connected to internet	
SNMP is version 1 compliant	
MIB files included in CD	

Available Options

- "UK" - UK standard power cord
- "DIN" - Germany and central Europe DIN connector
- "US" - US standard power cord
- "HIZ" - 10MHz option "HIZ" available
- "HIZ" - 1 sec PPS option "HIZ" available
- "N1" - use relay and opto for SSB T N+1 system



Broadcast Transport Stream Multiplexer



> XBT 529

Description

Multiplexer for 3 layers ISDB-T (188 bytes) which produces a BTS signal (204 bytes).

The XBT 529 is a multiplexer designed mainly to perform adaptation of data from TS (ISO/IEC 13818-1) to BTS (ABNT NBR 15601). The BTS to TS adaptation is provided by BTS to 188 bytes format encapsulation (BTS tunnelling) and a network adapter that generates, from multiple input Transport Streams (TS).

The XBT 529 manages 3 types of inputs: TS, BTS and BTS tunnel. The BTS tunnel is based on MBITL standard defined to enable the data transmission with radio links that allows only the 188 bytes format. In the BTS tunnel output, the BTS 204-bytes data are divided in 184 byte groups and to each group an MPEG-2TS 4 byte header is added.

The TS coming from ASI 1, 2 and 3 inputs are processed as layers, defined in the ISDB-T standard, to create a BTS:

1. ASI1: Layer A
2. ASI2: Layer B
3. ASI3: Layer C

Each layer input should be a TS composed by:

- data adapted to the bitrate specific for the layer to which the input is dedicated.
- empty packets (place holder packets) flagged with PID 0x1FFE adapted to layer A bitrate
- empty packets (place holder packets) flagged with PID 0x1FFD adapted to layer B bitrate
- empty packets (place holder packets) flagged with PID 0x1FFC adapted to layer C bitrate

The output packets format is 204 bytes. The last 16 bytes are filled with stuffing bits except the bits [0..4] of the byte 190 and the bits [0..7] of the byte 191 that are used for the packet counter reset each Multiplex Frame (defined by ISDB-T standard as a group of packets whose number is dependent on Modulation Mode and Guard Time).

The outputs bitrates and packets sequence are set according to the ISDB-T modulation configured.

The XBT-529 assembles the BTS output aligning the input Layer A, B and C TSs and removing the place holder PIDs. The 188 format TS input packets are increased to 204 by adding the 8 Transmission and Multiplexing Configuration Control (TMCC) bytes plus 8 stuffing bytes. The TMCC contains information about the relative packet type, packet position in the frame and eventually about AC data added as dummy data. In case of 204 format TS inputs packets the last 16 bytes are overwritten.

A group of packets whose number is dependent on Modulation Mode and Guard Time is defined as BTS Multiplex Frame (MF). For each output BTS MF the XBT 529 inserts an ISDB-T Information Packet (IIP) that contains information about layers modulation and eventually about network synchronization for SFN transmission.

All relevant IIP and TMCC parameters are configurable by user.

Layer A, layer B and layer C modulation parameters must be set aligned with the respective inputs bitrate.

The IIP and Null packets insertion sequence, to create the output BTS, depends on the modulation parameters set.

Main Features

Data Inputs

The BTS input can be provided through different physical input interfaces:

- ASI (8x);
- SPI (1x);
- GbE (2x).

Synchronization:

Input source device, XBT 529 and modulator have to be the 10MHz frequency reference synchronized to guarantee a single data bitrate reference.

In case of SFN transmission the synchronization is required for the 1PPS frequency reference.

The 10MHz and 1PPS synchronization is possible thanks to the selection of GPS or external source as frequency reference.

The 10MHz and 1PPS outputs permit to use a device as frequency reference source for the network following device.

Data Outputs:

The XBT 529 provides two types of outputs: BTS and BTS tunnel.

The output BTS is selectable between different input BTS:

1. BTS0: coming from ASI1, 2 and 3 inputs (Layer A, B, C) processing
2. BTS1: coming from the de-tunnelling of ASI4 input BTS tunnel
3. BTS2: coming from GbE 2 input BTS.
4. BTS3: coming from SPI input BTS

The output BTS tunnel comes from the tunnelling of the selected BTS. The BTS tunnel out packets PID is settable by user.



PHYSICAL	
Rack frame	1U
Size	(W) 484 mm x (H) 45 mm x (D) 346 mm
Weight	4kg

POWER SUPPLY	
90-270 VAC PFC corrected power supply	
Nominal power 38 VA	
Power factor: 0.95	
Max inrush current 15A	
M6 screw for extra ground connection	
Power cord	Default - Italy
	Option "UK" - UK standard
	Option "DIN" - Germany and central Europe DIN connector
	Option "US" - US standard

ASI INPUTS	
EN 500083-9 compliant	
BNC connectors 75 ohm	
Maximum bit rate 155 Mbit	

SPI INPUT	
EN 500083-9 compliant	
DB25 female connector	
Maximum bit rate 27 Mbytes	

ETHERNET CONNECTION	
10/100/1000 Mbit Ethernet connector	
1 IP address for web server, management, SNMP server, Telnet, TFTP and remote update	
1 IP address for RTP/UDP server	
1 IP address for RTP/UDP client	
RTP protocol: ProMpeg cop3 with no FEC packet processing/generation	

GPS INPUT	
TNC connector 50 ohm	
Phantom power 3 Volt 50 mA short circuit protected	
GPS L1	
12 channel simultaneous operation	
45 s typical cold start TTF	
38 s typical warm start TTF	
5 s typical hot start TTF	
<0.5 s reacquisition	
Sensitivity Acquisition/Tracking -185dBW / -185dBW	
30ns rms accuracy, <10ns resolution	

ASI OUTPUT	
EN 500083-9 compliant	
BNC connectors 75 ohm	
Maximum bit rate as per ISDB-T standard	

SPI OUTPUT	
EN 500083-9 compliant	
DB25 female connector	
Maximum bit rate as per DVB-T standard	

FRONT PANEL	
4 x 20 alpha displays	
8 button navigation	
Basic setup and status	

REFERENCE INPUTS	
10MHz	SMB connector
	1Vpp sine
	50 ohm terminated
	AC coupled
Option "HIZ" available	
1 sec PPS	SMB connector
	0.4 VIL
	1.7 VIH
	Dc coupled
	50 ohm terminated
	Option "HIZ" available

REFERENCE OUTPUTS	
10MHz	SMB connector
	1Vpp sine
	50 ohm
	DC coupled
1 sec PPS	SMB connector
	0.2 VOL @ 64 mA IOL
	2.2 VOH @ 64 mA IOH
	Dc coupled
	50 ohm capable

SOFTWARE	
Java applet requires Java 6 Version 13 or more recent	
Java applet tested on Safari, Internet Explorer, Mozilla	
Browser will download automatically suitable version of Java if connected to internet	
SNMP is version 1 compliant	
MIB files included in CD	

Available Options

- "UK" - UK standard power cord
- "DIN" - Germany and central Europe DIN connector
- "US" - US standard power cord
- "HIZ" - 10MHz option "HIZ" available
- "HIZ" - 1 sec PPS option "HIZ" available
- "N1" - use relay and opto for SSB T N+1 system

SDT ARK-6 Series



The Multiple Configuration Flexible Hardware Platform

The SDT ARK-6 is a Universal Driver with Multiple Front-End Boards

SDT ARK-6 SERIES. All configurations

Available front end configurations:

Transmitter only

Satellite Receiver Input

Satellite Receiver with Decoder and CAM Input

Analog A/V Input

Regenerative Trasmmitter



Specifications		
Frequency range	UHF (Band IV/V)	470 to 862 MHz, in 1 Hz Step
	VHF (Band III)	170 to 255 MHz, in 1 Hz Step
Available standards (all standards are full compliant)	Digital TV	DVB-T, DVB-T2, DVB-H, ISDB-Tb, ATSC, ATSC Mobile DTV ,DTMB
	Digital Audio Broadcasting	DAB,DAB+,T-DMB
	Analog TV	B/G, D/K, M, M1, N, I, I1
Power Supply	AC Line Voltage	380 to 415 (3 phases), 208 to 240 Delta or Star ; 47 Hz to 63 Hz To be specify at order
	AC Line variations	+/- 15%
	Power factor	≥ 0,98
Environmental Conditions	Altitude	2500 m above sea level (> 2500 m on request)
	Operating temperature range	-10 °C to +45 °C at sea level, upper limit derated of 2 °C per 300 m Above Mean Sea Level
	Relative humidity	95 %, not-condensing
	Cooling method	Forced Air / liquid with external heat exchanger with redounded fan
RF output	Output power variation range	+0,5 to -10 dB
	RF load impedance	50 Ohm
	VSWR	Power reduction after exceeding the set value or switch off after three attempts
	RF Output connector	See Specific Data Sheet
Transmitter size	Rack Unit	See Model Specific Data Sheet
	Weight	
	Dimension	
Synchronization	Reference frequency	10 MHz, 0.1 V to 5 V (Vpp) or TTL, BNC
	Reference pulse	1pps (1 Hz, TTL, BNC)
Operations Control and Monitoring	Remote	Web based Java Interface
		SNMP
		Telnet access via ethernet
	Local	Extensive front panel control Local terminal on RS232
Compliance and Conformity	RoHS	2002/95/EC
	R&TTE	1999/5/EC
	Safety	EN 60215
	EMC	EN 301-4891-1
	FCC	Part 73
	WEEE	2002/96/EC
	Manufacturing	ISO 9001:2008

Specifications are subject to change without notice



SDT SERIES ARK-6 DTV + ATV

Analog TV	standards	B/G, D/K, M, M1, N, I, I1	
	Color transmission	PAL, NTSC, SECAM	
	Sound transmission	IRT dual-sound coding, FM single sound and NICAM728 (13 dB/20 dB), FM single sound(-10 dB)	
	Inputs	1 x video , 2 x audio	
Video	Video input	0,5 to 1,5 V	
	Regulation of output power	+/- 3%	
	Variation of output power	+/- 2%	
	Differential gain	3%	
	Differential phase	3°	
	Low frequency linearity	8%	
	ICPM	+/- 2°	
	S/N	>60 dB	
	K Factor	2%	
	20 T	3%	
	Spurious and Harmonics radiation	>60 dB	
	In Channel IMD	> 58 dB	
	Sound	Modulation capability	+/- 120 KHz
		Monoaural input	settable 0 to 12 dBm
Pre-Emphasys		75 / 50 µS	
Frequency response		+/- 0,5 dB 30 to 15000 Hz	
Harmonic distorsion		0,5% 30 to 15000 Hz	
FM Noise		60 dB with de-emphasis	
AM Noise		50 dB 30 to 15000 Hz	
Synchronous AM noise		40 dB	
IRT Sound		available	
NICAM Sound		available	

The Universal DRIVER can be customised in 5 different configurations. All, always and easily upgradable to new features.



DVB T

DVB T2

DVB H

ATSC

a t s c
MOBILE DTV

ISDB-T

DTMB

The New SDT ARK-6 Series is the result of years of research and represents the state of the art of the worldwide transmitter technology. We call it UNIVERSAL DRIVER because of its incredible capability to be all configurations with one hardware and uploading a proper software package. It is perfect for both international broadcasters which have business in several countries – to increase manageability of investment through reduction of transmitter types - and national broadcasters, due for its versatility in operation modes and configuration. In fact it can be used as a transmitter, an heterodyne transposer, a regenerative transmitter, all in a single hardware. ARK-6 UNIVERSAL DRIVER is resilient to future evolutions of technology and standardization: this DRIVER guarantees a perfect upgrade path for new modulation schemes that the researchers will delivery. Besides ARK-6 UNIVERSAL DRIVER already implements DVB-T/T2, ATSC/MH, ISDB-T, DTMB, ATV modulations. The SDT ARK-6 allows selection of transmission modes in various ways: remotely, using a dry contact; via SNMP commands; via TCP/IP, using the Web graphic interface; or even via a dedicated command inserted into the transport stream. Functional interfaces are available for total remote control of the apparatus by means of serial protocols or TCP/IP ports. Thanks to the internal Web server the apparatus can be easily monitored and configured and updated using a LAN connection and a standard Web browser. More over, the built-in SNMP agent allows full automated remote control. It could be used as an exciter in a system or like standalone transmitter in several compact solution. The STD ARK 6 transmitters have a compact design. They are 19" wide, occupy 1 rack unit and contain all basic components such as transmitter input unit, modulator unit, output stage module, and display plus keypad. The housing fan is attached outside for easy access. In addition, the transmitters can accommodate a variety of options. The transmitters can be set up wherever required and are easy to transport. The broadband output stages are based on powerful LDMOS transistors and feature high efficiency.

HW OPTIONS						
Front-End	STANDARD					
	ATV	DVB-T/H	DVB-T2	ISDBT	ATSC	DMBT
None	Transmitter	Transmitter	Transmitter	Transmitter	Transmitter	Transmitter
Digitalizer A/V Input option	Transmitter with A/V analog inputs	X	X	X	X	X
DVB-S/S2	X	Transmitter with DVB-S/S2 RF input	Transmitter with DVB-S/S2 RF input	Transmitter with DVB-S/S2 RF input	Transmitter with DVB-S/S2 RF input	Transmitter with DVB-S/S2 RF input
DVB-S/S2 + CAM	X	Transmitter with DVB-S/S2 RF input (with CAM)	Transmitter with DVB-S/S2 RF input (with CAM)	Transmitter with DVB-S/S2 RF input (with CAM)	Transmitter with DVB-S/S2 RF input (with CAM)	Transmitter with DVB-S/S2 RF input (with CAM)
DVB-T/T2	X	Regenerative Transposer / Heterodyne Transposer / GapFiller Echo Canceller	Regenerative Transposer / Heterodyne Transposer / GapFiller Echo Canceller	X	X	X
ISDBT	X	X	X	Regenerative Transposer / Heterodyne Transposer / GapFiller Echo Canceller	X	X
ATSC	X	X	X	X	Regenerative Transposer / Heterodyne Transposer / GapFiller Echo Canceller	X
DTMB	X	X	X	X	X	Regenerative Transposer / Heterodyne Transposer / GapFiller Echo Canceller





Front View. Transmitter with Satellite Receiver

1. DVB-S2 Input Configuration – Satellite Input Specifications

- N. SAT Inputs: 1
- Connector type: F Female
- Input impedance: 75 ohm
- Input level: -81 dB up to -17 dB
- Supported symbol rates: 1 to 45 Msymb/s (DVB-S) / 1 to 67.5 (DVB-S2 depending on modulation scheme).
- DiSEqC: 2.0
- TS interface: broadcast reception and ISI filtering supported.
- Supported standards: ETSI EN 302 307 (DVB-S2)
- DVB-T/T2 available



Front View. Transmitter with Satellite Receiver with Decoder and CAM

2. DVB-S2 Input with DEC and CAM Configuration – Satellite and CAM Specifications

- N. GPS Inputs: 1
- Connector type: F Female
- Input impedance: 75 ohm
- Input level: -81 dB up to -17 dB
- Supported symbol rates: 1 to 45 Msymb/s (DVB-S) / 1 to 67.5 (DVB-S2 depending on modulation scheme).
- DiSEqC: 2.0
- TS interface: broadcast reception and ISI filtering supported.
- Supported standards: ETSI EN 302 307 (DVB-S2)
- DVB-T/T2, ITU available
- Common Interface:
- N° card slots: 1
- Type: PCMCIA
- Supported CAM:



Front View. Transposer and Regenerative Transmitter

3. DVB-T/T2 Transposer and Regenerative Transmitter Configuration – Terrestrial RF IN Specifications

- N. RF Inputs: 1
- Connector type: N Female
- Input impedance: 50 ohm
- Input level: -81 dB up to -17 dB
- Supported standards: DVB-T/H, DVB-T2
- DVB-T/T2 available



Front View. Transmitter Only Version

4 Multistandard Transmitter Configuration

- Inputs: 4 ASI and 2 TSolP channels
- Output: 1 RF, 1 RF Monitor
 - 2 ASI and 2 TSolP channels for inputs bypass
- Synchronization: External or GPS
- Internal clock: Oven Controlled OCXO oscillator (10 MHz and 1 PPS)
- Output clock: 1 PPS and 10 MHz
- Test modes: CW, Force Null Packets and PRBS
- Management: Embedded SNMP v1 server
 - Embedded Web server
- GbE Ports: GbE 1: 10/100/1000 Base T Management port
 - GbE 2: 10/100/1000 Base T Data port
- Redundancy: Input autoswitch algorithm supported
- Security: Authentication for GUI access supported
- Configuration: Automatic loading of preset configurations supported.
- Automatic retrieving of configuration data from the RF input supported.
- DVB-T/T2 available



Front View. Transmitter with Analog A/V Inputs

5. Digitizer with Analog A/V Inputs Configuration – A/V Specifications

- N. CVBS inputs: 2
- Connector type: BNC
- Input impedance: 75 ohm
- Supported video standards: PAL B,D,G,H,I,M,N, NTSC
- Analog audio input
- N°Inputs: 2 L/R couples
- Connector type: XLR3 (Cannon f)
- Input impedance: 600 Ohm balanced
- Input Level: +6dBm +/- 6 dB
- Supported standards: EIA RF-297-A
- ITU available
- Inputs: 4 SDI, 2 CVBS and 2 L/R
- Supported Composite Standards: NTSC CVBS, PAL (B, D, G, H, I, M, N) CVBS
- Supported SDI Standard: SMPTE 259M-C – Component 4:2:2, 270Mb/s for 525 and 625 lines, 13.5 MHz sampling, 4x3 and 16x9 aspect ratios.
- Outputs: 1 RF, 1 RF Monitor
 - 2 SDI for inputs bypass
- Synchronization: External or GPS
- Internal clock: Oven Controlled OCXO oscillator (10 MHz and 1 PPS)
- Output clock: 1 PPS and 10 MHz
- Test modes: CW, CW AV, Mute Audio Carrier, Mute Audio, Audio Test Tone, Video In, SMPTE Bars, Horizontal Bars, Red Field, ITS0, ITS1, ITS2, ITS3 and ITS4.
- Management: Embedded SNMP v1 server
 - Embedded Web server
- GbE Ports: GbE 1: 10/100/1000 Base T Management port
- Redundancy: Input autoswitch algorithm supported
- Security: Authentication for GUI access supported.

Hardware Specifications

TYPE:	DESCRIPTION AND NUMBER:
ASI/SSI/SDI Input	Connectors used as ASI, SMPTE-310 or SDI:
	N° Inputs: 4
	Connector type: BNC
	Input impedance: 75 ohm
	Input voltage: 800 mVpp (500 to 1200mVpp)
PS RF Input	Supported standards:
	CEI EN 50083-9
	SMPTE 310
	SMPTE 259M
	N° Inputs: 1
10 MHz Input	Sensitivity: -185dBW
	Connectors: TNC
	N° Inputs: 1
1PPS Input	Connector: BNC
	Input impedance: 50 ohm
	Input voltage: TTL (min 1,7V)
ASI Output Monitor	Pulse width: 100us
	Connectors used for monitoring purposes:
	N° outputs: 2
	Connector type: BNC
	Input impedance: 75 ohm
10 MHz Output	Input voltage: 800 mVpp (500 to 1200mVpp)
	Supported standards:
	CEI EN 50083-9
	N° outputs: 1
1PPS Output	Connector: SMB
	Output impedance: 50 ohm
	Output voltage: 2 Vpp
	N° Outputs: 1
	Connector: SMB
Gigabit Ethernet	Z load: 50 ohm
	Output voltage: TTL (min 2,4V)
	Pulse width: 100us
	N° connectors: 2
	Connector: RJ45
	Supported standards: IEEE 802.3

TYPE:	DESCRIPTION AND NUMBER:
Relays	N° outputs: 4
	Connectors: SUB-D 25p Female
	Max voltage: 125VAC / 60VDC @ 0,3A - 30VDC @ 1A
Opto	N° inputs: 4
	Connectors: SUB-D 25p Female
RF Front-End input	Max current: -5 mA
	Please refer to various configurations for a complete description of all the available Front-end modules
RF Measure board inputs	N° Inputs: 1
	Connector type:
	Input impedance: 50 ohm
	Input level: -40 dB up to -8.5 dB
	Supported standards:
DB9 – RS232	DVB-T/H, ISDB-T, ATSC, DVB-T2, DTMB
	N° inputs: 1
	Speed: up to 230400 bps
	8-bit data
DB9 – RS485	No parity bits
	1 stop bit
CAM BUS	N° inputs: 1
DB15 – TLC	N° inputs: 1
DB25 – TLS	N° inputs: 1

Specifications		
Frequency range	UHF (Band IV/V)	470 to 862 MHz, in 1 Hz Step
	VHF (Band III)	170 to 255 MHz, in 1 Hz Step
Available standards (all standars are full compliant)	Digital TV	DVB-T, DVB-T2, DVB-H, ISDB-Tb, ATSC, ATSC Mobile DTV,DTMB
	Digital Audio Broadcasting	DAB,DAB+,T-DMB
	Analog TV	B/G, D/K, M, M1, N, I, I1
Power Supply	AC Line Voltage	380 to 415 (3 phases), 208 to 240 Delta or Star ; 47 Hz to 63 Hz To be specify at order
	AC Line variations	+/- 15%
	Power factor	≥ 0,98
Environmental Conditions	Altitude	2500 m above sea level (> 2500 m on request)
	Operating temperature range	-10 °C to +45 °C at sea level, upper limit derated of 2 °C per 300 m Above Mean Sea Level
	Relative humidity	95 %, not-condensing
	Cooling method	Forced Air / liquid with external heat exchanger with redounded fan
RF output	Output power variation range	+0,5 to -10 dB
	RF load impedance	50 Ohm
	VSWR	Power reduction after exceeding the set value or switch off after three attempts
	RF Output connector	See Specific Data Sheet
Transmitter size	Rack Unit	See Model Specific Data Sheet
	Weight	
	Dimension	
Synchronization	Reference frequency	10 MHz, 0.1 V to 5 V (Vpp) or TTL, BNC
	Reference pulse	1pps (1 Hz, TTL, BNC)
Operations Control and Monitoring	Remote	Web based Java Interface
		SNMP
		Telnet access via ethernet
	Local	Extensive front panel control
		Local terminal on RS232
Compliance and Conformity	RoHS	2002/95/EC
	R&TTE	1999/5/EC
	Safety	EN 60215
	EMC	EN 301-4891-1
	FCC	Part 73
	WEEE	2002/96/EC
Manufacturing	ISO 9001:2008	

Specifications are subject to change without notice



SDT SERIES ARK-6 DVB + ATV

Models Selection Guide

Models	Output Band	Working Class	Dimensions	N. Ampl	kind of Ampl	Output Connector	Cooling	Meter board N.	Shoulders @ Fo ± 4.3 MHz	Digital output power (rms) without Filter ISDB-T	Nominal analog output power (p.s.) ATV
SDT 000UA ARK-6-HE	UHF	A	1 RU (19" rack), 400 mm			N	Air	-	-37	1mW	1mW
SDT 200UA ARK-6	UHF	A	1 RU (19" rack), 400 mm	1		N	Air	-	-36	2,5 W	80 W
SDT 200TB ARK-6	VHF (III)	A	1 RU (19" rack), 400 mm	1		N	Air	-	-36	2,5 W	80 W
SDT 500UB ARK-6	UHF	AB	1 RU (19" rack), 400 mm	1	SCA500UB	N	Air	-	-36	12 W	50 W
SDT 500TB ARK-6	VHF (III)	AB	1 RU (19" rack), 400 mm	1	SCA500TB	N	Air	-	-36	12 W	50 W
SDT 201UB ARK-6 HE C	UHF	AB	2 RU (19" rack), 400 mm	1		7/16"	Air	-	-39	150 W	400 W
SDT 201UB ARK-6 C	VHF (III)	AB	2 RU (19" rack), 400 mm	1		7/16"	Air	-	-36	80 W	250 W
SDT 201UB ARK-6 HE	UHF	AB	1+3 RU	1		7/16"	Air	-	-39	150 W	450 W
SDT 201UB ARK-6	UHF	AB	1+3 RU	1		7/16"	Air	-	-36	80 W	250 W
SDT 201TB ARK-6	VHF (III)	AB	1+3 RU	1		7/16"	Air	-	-36	80 W	250 W
SDT 501UB ARK-6 HE C	UHF	AB	3 RU	1		7/16"	Air	-	-39	300 W	800 W
SDT 501UB ARK-6 C	UHF	AB	3 RU	1		7/16"	Air	-	-36	150 W	700 W
SDT 501TB ARK-6 C	VHF (III)	AB	3 RU	1		7/16"	Air	-	-36	150 W	700 W
SDT 501UB ARK-6 HE	UHF	AB	15 RU (4+1)	1	SCA501	7/16"	Air	-	-39	350 W	1000 W
SDT 501UB ARK-6	UHF	AB	15 RU (4+1)	1	SCA501	7/16"	Air	-	-36	150 W	700 W
SDT 501TB ARK-6	VHF (III)	AB	15 RU (4+1)	1	SCA501	7/16"	Air	-	-36	150 W	700 W
SDT 102UB ARK-6 HE	UHF	AB	1+5 RU	1	SCA102HE	7/16"	Air	-	-39	700 W	2000 W
SDT 102UM ARK-6 HE	UHF	AB	30 RU	2	SDT501HE	7/16"	Air	-	-39	700 W	2000 W
SDT 102UB ARK-6	UHF	AB	1+5 RU	1	SCA102UB	7/16"	Air	-	-36	300 W	1400 W
SDT 102UM ARK-6	UHF	AB	30RU	2	SCA501UB	7/16"	Air	-	-36	300 W	1400 W
SDT 102TB ARK-6	VHF (III)	AB	1+5 RU	1	SCA102TB	7/16"	Air	-	-36	300 W	1400 W
SDT 102TM ARK-6	VHF (III)	AB	30 RU	2	SCA501TB	7/16"	Air	-	-36	300 W	1400 W
SDT 202UB ARK-6 HE	UHF	AB	1+5 RU	1	SCA202HE	7/8"	Air	-	-39	1300 W	3000 W
SDT 202UM ARK-6 HE	UHF	AB	30 RU	2	SCA202HE	7/8"	Air	-	-39	1300 W	3000 W
SDT 202UB ARK-6	UHF	AB	1+5 RU	1	SCA202UB	7/8"	Air	-	-36	700 W	2800 W
SDT 202UM ARK-6	UHF	AB	30RU	2	SCA202UB	7/8"	Air	-	-36	700 W	2800 W
SDT 202TB ARK-6	VHF (III)	AB	1+5 RU	1	SCA202TB	7/8"	Air	-	-36	700 W	2800 W
SDT 202TM ARK-6	VHF (III)	AB	30 RU	2	SCA202TB	7/8"	Air	-	-36	700 W	2800 W
SDT 502UB ARK-6 HE	UHF	AB	30 RU	2	SCA202HE	1+5/8"	Air	1	-39	2600 W	6000 W
SDT 502UM ARK-6 HE	UHF	AB	40 RU	4	SCA102HE	1+5/8"	Air	1	-39	2600 W	6000 W
SDT 502UB-W ARK-6 HE	UHF	AB	40 RU	2	SCA202HE-W	1+5/8"	Liquid	1	-39	2600 W	6000 W
SDT502UB ARK-6	UHF	AB	30 RU	2	SCA202UB	1+5/8"	Air	1	-36	1300 W	5000 W
SDT502UB-W ARK-6	UHF	AB	40 RU	2	SCA202UB-W	1+5/8"	Liquid	1	-36	1300 W	5000 W
SDT 502UM ARK-6	UHF	AB	40 RU	4	SCA102UB	1+5/8"	Air	1	-36	1300 W	5000 W
SDT 502TB ARK-6	VHF (III)	AB	30 RU	2	SCA202TB	1+5/8"	Air	1	-36	1300 W	5000 W
SDT 502TB-W ARK-6	VHF (III)	AB	40 RU	2	SCA202TB-W	1+5/8"	Liquid	1	-36	1300 W	5000 W
SDT 502TM ARK-6	VHF (III)	AB	40 RU	4	SCA102TB	1+5/8"	Air	1	-36	1300 W	5000 W
SDT 532UB-W ARK-6 HE	UHF	AB	40 RU	3	SCA202HE-W	1+5/8"	Liquid	1	-39	3900 W	9000 W
SDT 532UB-W ARK-6	UHF	AB	40 RU	3	SCA202UB-W	1+5/8"	Liquid	1	-36	2000 W	7500 W
SDT 532TB-W ARK-6	VHF (III)	AB	40 RU	3	SCA202TB-W	1+5/8"	Liquid	1	-36	2000 W	7500 W
SDT 103UM ARK-6 HE	UHF	AB	40 RU	4	SCA202HE	3+1/8"	Air	1	-39	5200 W	12000 W
SDT 103UM-W ARK-6 HE	UHF	AB	40 RU	4	SCA202HE	3+1/8"	Liquid	1	-39	5200 W	12000 W
SDT 103UM ARK-6	UHF	AB	40 RU	4	SCA202UB	3+1/8"	Air	1	-36	2600 W	10000 W
SDT 103UM-W ARK-6	UHF	AB	40 RU	4	SCA202UB-W	3+1/8"	Liquid	1	-36	2600 W	10000 W
SDT 103TM ARK-6	VHF (III)	AB	40 RU	4	SCA202TB	3+1/8"	Air	1	-36	2600 W	10000 W
SDT 103TM-W ARK-6	VHF (III)	AB	40 RU	4	SCA202TB-W	3+1/8"	Liquid	1	-36	2600 W	10000 W
SDT 123UM-W ARK-6	UHF	AB	40 RU	5	SCA202UB-W	3+1/8"	Liquid	1	-36	3200 W	12500 W
SDT 123TM-W ARK-6	VHF (III)	AB	40 RU	5	SCA202TB-W	3+1/8"	Liquid	1	-36	3200 W	12500 W
SDT 133UM-W ARK-6 HE	UHF	AB	2 x 40 RU	6	SCA202HE-W	3+1/8"	Liquid	1	-39	7800 W	18000 W
SDT 133UM-W ARK-6	UHF	AB	2 x 40 RU	6	SCA202UB-W	3+1/8"	Liquid	1	-36	6000 W	16000 W
SDT 133TM-W ARK-6	VHF (III)	AB	2 x 40 RU	6	SCA202TB-W	3+1/8"	Liquid	1	-36	6000 W	16000 W
SDT 203UM ARK-6 HE	UHF	AB	2 x 40 RU	8	SCA202HE	3+1/8"	Air	2	-39	10000 W	24000 W
SDT 203UM-W ARK-6 HE	UHF	AB	2 x 40 RU	8	SCA202HE	3+1/8"	Liquid	2	-39	10000 W	24000 W
SDT 203UM ARK-6	UHF	AB	2 x 40 RU	8	SCA202UB	3+1/8"	Air	2	-36	5000 W	20000 W
SDT 203UM-W ARK-6	UHF	AB	2 x 40 RU	8	SCA202UB-W	3+1/8"	Liquid	2	-36	5000 W	20000 W
SDT 203TM ARK-6	VHF (III)	AB	2 x 40 RU	8	SCA202TB	3+1/8"	Air	2	-36	5000 W	20000 W
SDT 203TM-W ARK-6	VHF (III)	AB	2 x 40 RU	8	SCA202TB-W	3+1/8"	Liquid	2	-36	5000 W	20000 W
SDT 303UM-W ARK-6 HE	UHF	AB	3 X 40 RU	12	SCA202HE-W	4+1/2"	Liquid	4	-39	15000 W	36000 W
SDT 303UM-W ARK-6	UHF	AB	3 X 40 RU	12	SCA202UB-W	4+1/2"	Liquid	4	-36	7800 W	32000 W
SDT 303TM-W ARK-6	VHF (III)	AB	3 X 40 RU	12	SCA202TB-W	4+1/2"	Liquid	4	-36	7800 W	32000 W
SDT 403UM-W ARK-6 HE	UHF	AB	4 X 40 RU	16	SCA202HE-W	4+1/2"	Liquid	4	-39	20000 W	48000 W
SDT 403UM-W ARK-6	UHF	AB	4 X 40 RU	16	SCA202UB-W	4+1/2"	Liquid	4	-36	10000 W	40000 W
SDT 403TM-W ARK-6	VHF (III)	AB	4 X 40 RU	16	SCA202TB-W	4+1/2"	Liquid	4	-36	10000 W	40000 W
SDT 603UM-W ARK-6 HE	UHF	AB	6 X 40 RU	24	SCA202HE-W	6+1/8"	Liquid	6	-39	30000 W	72000 W
SDT 603UM-W ARK-6	UHF	AB	6 X 40 RU	24	SCA202UB-W	6+1/8"	Liquid	6	-36	15000 W	64000 W
SDT 603TM-W ARK-6	VHF (III)	AB	6 X 40 RU	24	SCA202TB-W	6+1/8"	Liquid	6	-36	15000 W	64000 W

Specifications and characteristics are subject to change without notice.

ISDB-T Transmitter/modulator up to 1mW rms



> SDT 000 ARK-DTMB

Description

The New SDT ARK-6 Series is the result of years of research and represents the state of the art of the worldwide transmitter technology.

We call it UNIVERSAL DRIVER because of its incredible capability to be all configurations with one hardware and uploading a proper software package.

It is perfect for both international broadcasters which have business in several countries – to increase manageability of investment through reduction of transmitter types – and national broadcasters, due for its versatility in operation modes and configuration. In fact it can be used as a transmitter, a heterodyne transposer, a regenerative transmitter, all in a single hardware.

ARK-6 UNIVERSAL DRIVER is resilient to future evolutions of technology and standardization: this DRIVER guarantees a perfect upgrade path for new modulation schemes that the researchers will delivery.

Besides ARK-6 UNIVERSAL DRIVER already implements DVB-T/T2, ATSC/MH, ISDB-T, DTMB, ATV modulations.

The SDT ARK-6 allows selection of transmission modes in various ways: remotely, using a dry contact; via SNMP commands; via TCP/IP, using the Web graphic interface; or even via a dedicated command inserted into the transport stream.

Functional interfaces are available for total remote control of the apparatus by means of serial protocols or TCP/IP ports. Thanks to the internal Web server the apparatus can be easily monitored and configured and updated using a LAN connection and a standard Web browser. More over, the built-in SNMP agent allows full automated remote control.

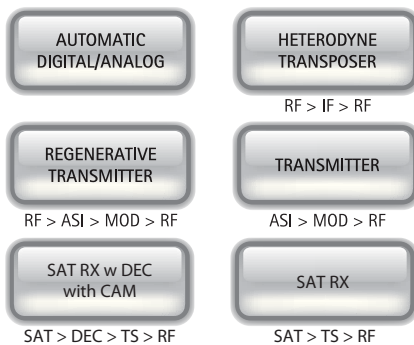

Main Features

- Transmission in VHF and UHF bands
- MFN and SFN operations
- Internal GPS receiver
- Embedded HTTP server
- RF main and monitoring outputs
- Linear and Non-Linear Adaptive digital pre-correction circuits, when operated as transmitter
- Linear and non-linear digital pre-correction circuits, when operated as repeater
- T2-MI input over IP or ASI
- Modulated DVB-T2 RF signal input (VHF/UHF) – when operating as repeater
- T2-MI input RF signal (VHF/UHF) – specific for SFN gap filler operation
- Signal modulation compliant with ETSI EN-302 755 (DVB-T2) standard 1.3.1
- ETSI EN 300 744 v16.1
- ETSI TS 101 191 v1.4.1
- ETSI EN-102 773 (T2-MI)
- ITU -R BT. 470-7
- Full support of T2 modulation up to 256-QAM including I/Q rotation
- T2-MI compliant with standard
- Full Single-PLP and MPLP compatibility (including MISO and PAPR reduction)
- Up to 16 PLP
- Bit rate adaptation plus PCR restamping in S-PLP

Option Features

Based on Software Defined Technology (SWDT), ARK6 T2 Modulator allows the definition of different operative modes on the same hardware platform.



SDT SERIES ARK-6 ISDB-T + ATV

The New SDT ARK-6 SERIES is available in different hardware configurations.



Front View. Transposer and Transmitter Version



Front View. Version with Analog Audio/Video Input



Front View. Transmitter with DVB-S2 Receiver Version



Front View. Transmitter with DVB-S2 Receiver Version with CAM



Front View. Transmitter Version

General Specifications	
Cooling System	Forced air/liquid cooling
Local control and monitoring	Extensive front panel control Local terminal on RS-232
Remote control and monitoring	Web based Java Interface Telnet access via Ethernet SNMP
Operating Temperature	-10°C to +45°C
Maximum relative humidity	90%, non condensing
Maximum operating altitude	2500 m a.s.l. (> 2500 m on request)
Mains power supply	90-260 VAC, 380 VAC (3 Phases) other available on request

MODEL SPECIFIC DATA											
Models	Output Band	Working Class	Dimensions	N. Ampl	kind of Ampl	Output Connector	Cooling	Meter board N.	Shoulders @ Fo ± 4.3 MHz	Digital output power (rms) without Filter ISDB-T	Nominal analog output power (p.s.) ATV
SDT000UA ARK-6	UHF	A	1 RU (19" rack), 400 mm	-	-	N	Air	-	-37	1mW	1mW

Specifications and characteristics are subject to change without notice.

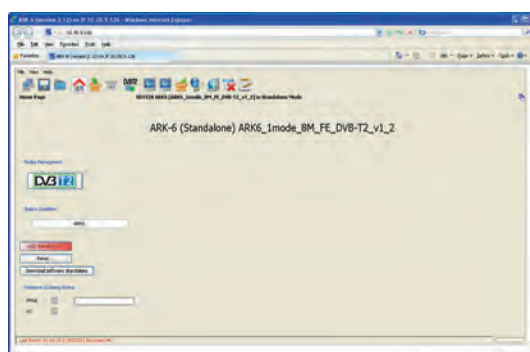

GUI, modulation page.



GUI, main page.



GUI, input page.

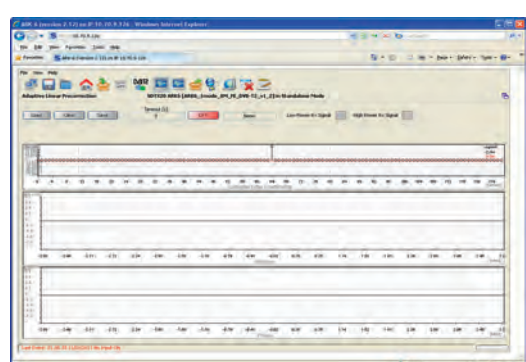

GUI, linear pre correction page.

Heterodyne Transposer, Regenerative Transmitter, Transmitter 20W ps/2,5W rms



> SDT 200 ARK-6

Description

The New SDT ARK-6 Series is the result of years of research and represents the state of the art of the worldwide transmitter technology.

We call it UNIVERSAL DRIVER because of its incredible capability to be all configurations with one hardware and uploading a proper software package.

It is perfect for both international broadcasters which have business in several countries – to increase manageability of investment through reduction of transmitter types – and national broadcasters, due to its versatility in operation modes and configuration. In fact it can be used as a transmitter, a heterodyne transposer, a regenerative transmitter, all in a single hardware.

ARK-6 UNIVERSAL DRIVER is resilient to future evolutions of technology and standardization: this DRIVER guarantees a perfect upgrade path for new modulation schemes that the researchers will delivery.

Besides ARK-6 UNIVERSAL DRIVER already implements DVB-T/T2, ATSC/MH, ISDB-T, DTMB, ATV modulations.

The SDT ARK-6 allows selection of transmission modes in various ways: remotely, using a dry contact; via SNMP commands; via TCP/IP, using the Web graphic interface; or even via a dedicated command inserted into the transport stream.

Functional interfaces are available for total remote control of the apparatus by means of serial protocols or TCP/IP ports. Thanks to the internal Web server the apparatus can be easily monitored and configured and updated using a LAN connection and a standard Web browser. More over, the built-in SNMP agent allows full automated remote control.

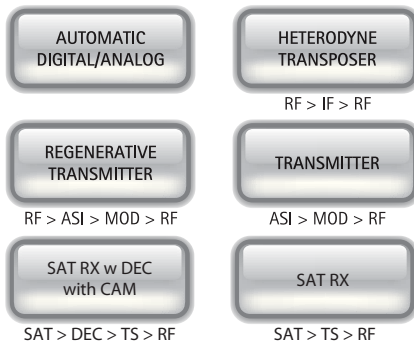

Main Features

- Transmission in VHF and UHF bands
- MFN and SFN operations
- Internal GPS receiver
- Embedded HTTP server
- RF main and monitoring outputs
- Linear and Non-Linear Adaptive digital pre-correction circuits, when operated as transmitter
- Linear and non-linear digital pre-correction circuits, when operated as repeater
- T2-MI input over IP or ASI
- Modulated DVB-T2 RF signal input (VHF/UHF) – when operating as repeater
- T2-MI input RF signal (VHF/UHF) – specific for SFN gap filler operation
- Signal modulation compliant with ETSI EN-302 755 (DVB-T2) standard 1.3.1
- ETSI EN 300 744 v16.1
- ETSI TS 101 191 v1.4.1
- ETSI EN-102 773 (T2-MI)
- ITU -R BT. 470-7
- Full support of T2 modulation up to 256-QAM including I/Q rotation
- T2-MI compliant with standard
- Full Single-PLP and MPLP compatibility (including MISO and PAPR reduction)
- Up to 16 PLP
- Bit rate adaptation plus PCR restamping in S-PLP

Option Features

Based on Software Defined Technology (SWDT), ARK6 T2 Modulator allows the definition of different operative modes on the same hardware platform.



SDT SERIES ARK-6 ISDB-T + ATV

The New SDT ARK-6 SERIES is available in different hardware configurations.



Front View. Transposer and Transmitter Version



Front View. Version with Analog Audio/Video Input



Front View. Transmitter with DVB-S2 Receiver Version



Front View. Transmitter with DVB-S2 Receiver Version with CAM



Front View. Transmitter Version

General Specifications	
Cooling System	Forced air/liquid cooling
Local control and monitoring	Extensive front panel control Local terminal on RS-232
Remote control and monitoring	Web based Java Interface Telnet access via Ethernet SNMP
Operating Temperature	-10°C to +45°C
Maximum relative humidity	90%, non condensing
Maximum operating altitude	2500 m a.s.l. (> 2500 m on request)
Mains power supply	90-260 VAC, 380 VAC (3 Phases) other available on request

MODEL SPECIFIC DATA

Models	Output Band	Working Class	Dimensions	N. Ampl	kind of Ampl	Output Connector	Cooling	Meter board N.	Shoulders @ Fo ± 4.3 MHz	Digital output power (rms) without Filter ISDB-T	Nominal analog output power (p.s.) ATV
SDT 200UA ARK-6	UHF	A	1 RU (19" rack), 400 mm	1	-	N	Air	-	-36	2,5 W	80 W
SDT 200TB ARK-6	VHF (III)	A	1 RU (19" rack), 400 mm	1	-	N	Air	-	-36	2,5 W	80 W

Specifications and characteristics are subject to change without notice.

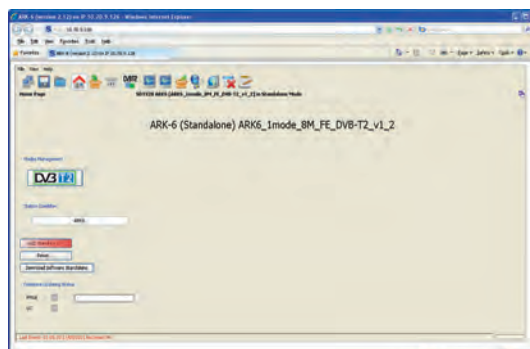

GUI, modulation page.

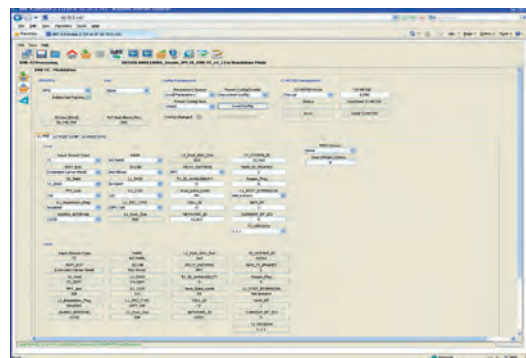

GUI, main page.



GUI, input page.



GUI, linear pre correction page.

Heterodyne Transposer, Regenerative Transmitter, Transmitter 50W ps/12W rms



> SDT 500 ARK-6

Description

The New SDT ARK-6 Series is the result of years of research and represents the state of the art of the worldwide transmitter technology.

We call it UNIVERSAL DRIVER because of its incredible capability to be all configurations with one hardware and uploading a proper software package.

It is perfect for both international broadcasters which have business in several countries – to increase manageability of investment through reduction of transmitter types – and national broadcasters, due for its versatility in operation modes and configuration. In fact it can be used as a transmitter, a heterodyne transposer, a regenerative transmitter, all in a single hardware.

ARK-6 UNIVERSAL DRIVER is resilient to future evolutions of technology and standardization: this DRIVER guarantees a perfect upgrade path for new modulation schemes that the researchers will delivery.

Besides ARK-6 UNIVERSAL DRIVER already implements DVB-T/T2, ATSC/MH, ISDB-T, DTMB, ATV modulations.

The SDT ARK-6 allows selection of transmission modes in various ways: remotely, using a dry contact; via SNMP commands; via TCP/IP, using the Web graphic interface; or even via a dedicated command inserted into the transport stream.

Functional interfaces are available for total remote control of the apparatus by means of serial protocols or TCP/IP ports. Thanks to the internal Web server the apparatus can be easily monitored and configured and updated using a LAN connection and a standard Web browser. More over, the built-in SNMP agent allows full automated remote control.

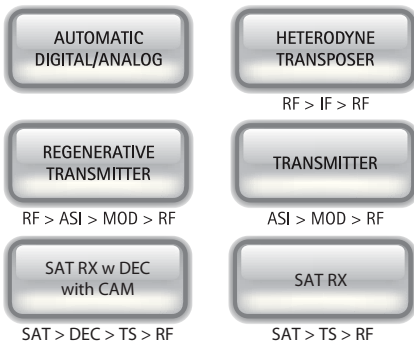

Main Features

- Transmission in VHF and UHF bands
- MFN and SFN operations
- Internal GPS receiver
- Embedded HTTP server
- RF main and monitoring outputs
- Linear and Non-Linear Adaptive digital pre-correction circuits, when operated as transmitter
- Linear and non-linear digital pre-correction circuits, when operated as repeater
- T2-MI input over IP or ASI
- Modulated DVB-T2 RF signal input (VHF/UHF) – when operating as repeater
- T2-MI input RF signal (VHF/UHF) – specific for SFN gap filler operation
- Signal modulation compliant with ETSI EN-302 755 (DVB-T2) standard 1.3.1
- ETSI EN 300 744 v16.1
- ETSI TS 101 191 v1.4.1
- ETSI EN-102 773 (T2-MI)
- ITU -R BT. 470-7
- Full support of T2 modulation up to 256-QAM including I/Q rotation
- T2-MI compliant with standard
- Full Single-PLP and MPLP compatibility (including MISO and PAPR reduction)
- Up to 16 PLP
- Bit rate adaptation plus PCR restamping in S-PLP

Option Features

Based on Software Defined Technology (SWDT), ARK6 T2 Modulator allows the definition of different operative modes on the same hardware platform.



SDT SERIES ARK-6 ISDB-T + ATV

The New SDT ARK-6 SERIES is available in different hardware configurations.



Front View. Transposer and Transmitter Version



Front View. Version with Analog Audio/Video Input



Front View. Transmitter with DVB-S2 Receiver Version



Front View. Transmitter with DVB-S2 Receiver Version with CAM



Front View. Transmitter Version

General Specifications	
Cooling System	Forced air/liquid cooling
Local control and monitoring	Extensive front panel control Local terminal on RS-232
Remote control and monitoring	Web based Java Interface Telnet access via Ethernet SNMP
Operating Temperature	-10°C to +45°C
Maximum relative humidity	90%, non condensing
Maximum operating altitude	2500 m a.s.l. (> 2500 m on request)
Mains power supply	90-260 VAC, 380 VAC (3 Phases) other available on request

MODEL SPECIFIC DATA

Models	Output Band	Working Class	Dimensions	N. Ampl	kind of Ampl	Output Connector	Cooling	Meter board N.	Shoulders @ $F_{0 \pm 4.3 \text{ MHz}}$	Digital output power (rms) without Filter ISDB-T	Nominal analog output power (p.s.) ATV
SDT 500UB ARK-6	UHF	AB	1 RU (19" rack), 400 mm	1	SCA500UB	N	Air	-	-36	12 W	50 W
SDT 500TB ARK-6	VHF (III)	AB	1 RU (19" rack), 400 mm	1	SCA500TB	N	Air	-	-36	12 W	50 W

Specifications and characteristics are subject to change without notice.

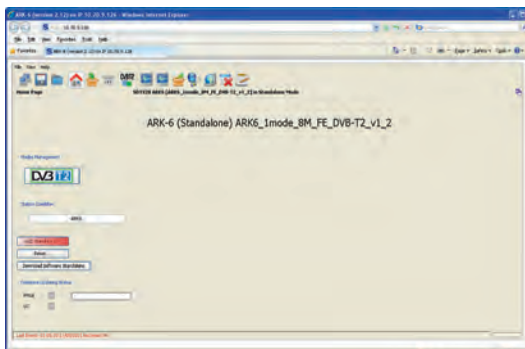

GUI, modulation page.

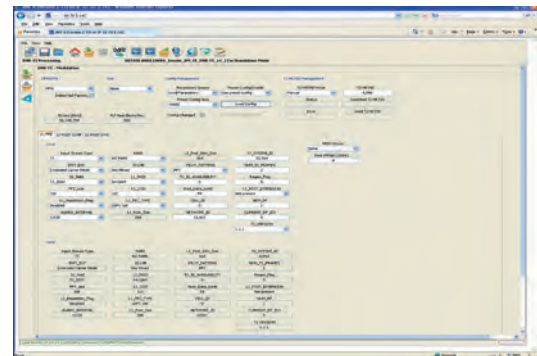

GUI, main page.



GUI, input page.



GUI, linear pre correction page.

Heterodyne Transposer, Regenerative Transmitter, Transmitter, up to 400W ps/150W rms



> SDT 201 ARK-6

Description

The New SDT ARK-6 Series is the result of years of research and represents the state of the art of the worldwide transmitter technology.

We call it UNIVERSAL DRIVER because of its incredible capability to be all configurations with one hardware and uploading a proper software package.

It is perfect for both international broadcasters which have business in several countries – to increase manageability of investment through reduction of transmitter types – and national broadcasters, due for its versatility in operation modes and configuration. In fact it can be used as a transmitter, a heterodyne transposer, a regenerative transmitter, all in a single hardware.

ARK-6 UNIVERSAL DRIVER is resilient to future evolutions of technology and standardization: this DRIVER guarantees a perfect upgrade path for new modulation schemes that the researchers will delivery.

Besides ARK-6 UNIVERSAL DRIVER already implements DVB-T/T2, ATSC/MH, ISDB-T, DTMB, ATV modulations.

The SDT ARK-6 allows selection of transmission modes in various ways: remotely, using a dry contact; via SNMP commands; via TCP/IP, using the Web graphic interface; or even via a dedicated command inserted into the transport stream.

Functional interfaces are available for total remote control of the apparatus by means of serial protocols or TCP/IP ports. Thanks to the internal Web server the apparatus can be easily monitored and configured and updated using a LAN connection and a standard Web browser. More over, the built-in SNMP agent allows full automated remote control.

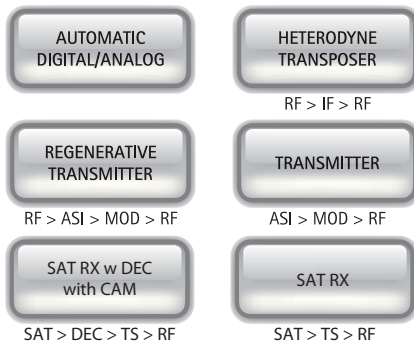

Main Features

- Transmission in VHF and UHF bands
- MFN and SFN operations
- Internal GPS receiver
- Embedded HTTP server
- RF main and monitoring outputs
- Linear and Non-Linear Adaptive digital pre-correction circuits, when operated as transmitter
- Linear and non-linear digital pre-correction circuits, when operated as repeater
- T2-MI input over IP or ASI
- Modulated DVB-T2 RF signal input (VHF/UHF) – when operating as repeater
- T2-MI input RF signal (VHF/UHF) – specific for SFN gap filler operation
- Signal modulation compliant with ETSI EN-302 755 (DVB-T2) standard 1.3.1
- ETSI EN 300 744 v16.1
- ETSI TS 101 191 v1.4.1
- ETSI EN-102 773 (T2-MI)
- ITU -R BT. 470-7
- Full support of T2 modulation up to 256-QAM including I/Q rotation
- T2-MI compliant with standard
- Full Single-PLP and MPLP compatibility (including MISO and PAPR reduction)
- Up to 16 PLP
- Bit rate adaptation plus PCR restamping in S-PLP

Option Features

Based on Software Defined Technology (SWDT), ARK6 T2 Modulator allows the definition of different operative modes on the same hardware platform.



SDT SERIES ARK-6 ISDB-T + ATV

The New SDT ARK-6 SERIES is available in different hardware configurations.



Front View. Transposer and Transmitter Version



Front View. Version with Analog Audio/Video Input



Front View. Transmitter with DVB-S2 Receiver Version



Front View. Transmitter with DVB-S2 Receiver Version with CAM



Front View. Transmitter Version

General Specifications	
Cooling System	Forced air/liquid cooling
Local control and monitoring	Extensive front panel control Local terminal on RS-232
Remote control and monitoring	Web based Java Interface Telnet access via Ethernet SNMP
Operating Temperature	-10°C to +45°C
Maximum relative humidity	90%, non condensing
Maximum operating altitude	2500 m a.s.l. (> 2500 m on request)
Mains power supply	90-260 VAC, 380 VAC (3 Phases) other available on request

MODEL SPECIFIC DATA

Models	Output Band	Working Class	Dimensions	N. Ampl	kind of Ampl	Output Connector	Cooling	Meter board N.	Shoulders @ Fo ± 4.3 MHz	Digital output power (rms) without Filter ISDB-T	Nominal analog output power (p.s.) ATV
SDT 201UB ARK-6 HE C	UHF	AB	2 RU (19" rack), 400 mm	1	-	7/16"	Air	-	-39	150 W	400 W
SDT 201UB ARK-6 C	VHF (III)	AB	2 RU (19" rack), 400 mm	1	-	7/16"	Air	-	-36	80 W	250 W

Specifications and characteristics are subject to change without notice.

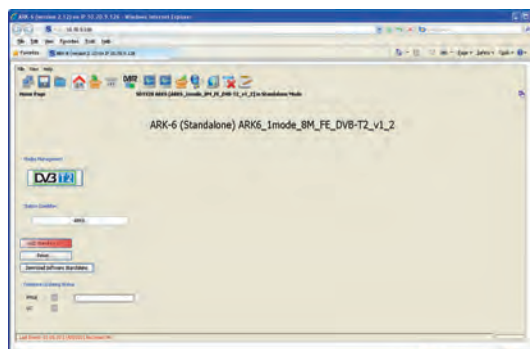

GUI, modulation page.

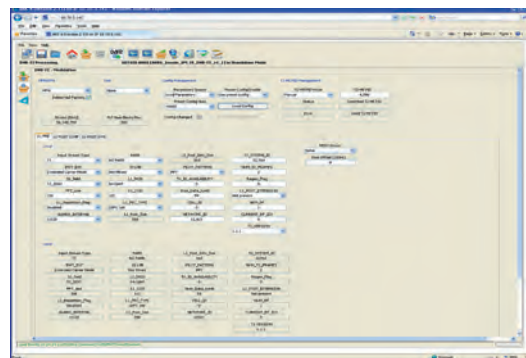

GUI, main page.



GUI, input page.

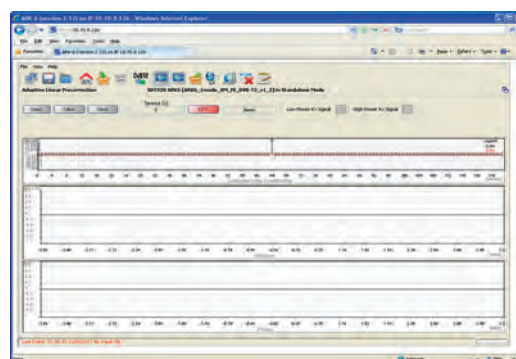

GUI, linear pre correction page.

Heterodyne Transposer, Regenerative Transmitter, Transmitter up to 450W ps/150W rms



> SDT 201 ARK-6 NC

Description

The New SDT ARK-6 Series is the result of years of research and represents the state of the art of the worldwide transmitter technology.

We call it UNIVERSAL DRIVER because of its incredible capability to be all configurations with one hardware and uploading a proper software package.

It is perfect for both international broadcasters which have business in several countries – to increase manageability of investment through reduction of transmitter types – and national broadcasters, due to its versatility in operation modes and configuration. In fact it can be used as a transmitter, a heterodyne transposer, a regenerative transmitter, all in a single hardware. ARK-6 UNIVERSAL DRIVER is resilient to future evolutions of technology and standardization: this DRIVER guarantees a perfect upgrade path for new modulation schemes that the researchers will delivery.

Besides ARK-6 UNIVERSAL DRIVER already implements DVB-T/T2, ATSC/MH, ISDB-T, DTMB, ATV modulations.

The SDT ARK-6 allows selection of transmission modes in various ways: remotely, using a dry contact; via SNMP commands; via TCP/IP, using the Web graphic interface; or even via a dedicated command inserted into the transport stream.

Functional interfaces are available for total remote control of the apparatus by means of serial protocols or TCP/IP ports. Thanks to the internal Web server the apparatus can be easily monitored and configured and updated using a LAN connection and a standard Web browser. Moreover, the built-in SNMP agent allows full automated remote control.

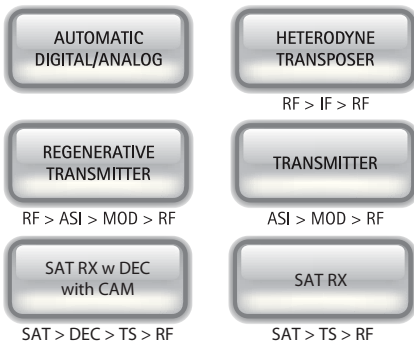

Main Features

- Transmission in VHF and UHF bands
- MFN and SFN operations
- Internal GPS receiver
- Embedded HTTP server
- RF main and monitoring outputs
- Linear and Non-Linear Adaptive digital pre-correction circuits, when operated as transmitter
- Linear and non-linear digital pre-correction circuits, when operated as repeater
- T2-MI input over IP or ASI
- Modulated DVB-T2 RF signal input (VHF/UHF) – when operating as repeater
- T2-MI input RF signal (VHF/UHF) – specific for SFN gap filler operation
- Signal modulation compliant with ETSI EN-302 755 (DVB-T2) standard 1.3.1
- ETSI EN 300 744 v16.1
- ETSI TS 101 191 v1.4.1
- ETSI EN-102 773 (T2-MI)
- ITU -R BT. 470-7
- Full support of T2 modulation up to 256-QAM including I/Q rotation
- T2-MI compliant with standard
- Full Single-PLP and MPLP compatibility (including MISO and PAPR reduction)
- Up to 16 PLP
- Bit rate adaptation plus PCR restamping in S-PLP

Option Features

Based on Software Defined Technology (SWDT), ARK6 T2 Modulator allows the definition of different operative modes on the same hardware platform.



SDT SERIES ARK-6 ISDB-T + ATV

The New SDT ARK-6 SERIES is available in different hardware configurations.



Front View. Transposer and Transmitter Version



Front View. Version with Analog Audio/Video Input



Front View. Transmitter with DVB-S2 Receiver Version



Front View. Transmitter with DVB-S2 Receiver Version with CAM



Front View. Transmitter Version

General Specifications	
Cooling System	Forced air/liquid cooling
Local control and monitoring	Extensive front panel control Local terminal on RS-232
Remote control and monitoring	Web based Java Interface Telnet access via Ethernet SNMP
Operating Temperature	-10°C to +45°C
Maximum relative humidity	90%, non condensing
Maximum operating altitude	2500 m a.s.l. (> 2500 m on request)
Mains power supply	90-260 VAC, 380 VAC (3 Phases) other available on request

MODEL SPECIFIC DATA

Models	Output Band	Working Class	Dimensions	N. Ampl	kind of Ampl	Output Connector	Cooling	Meter board N.	Shoulders @ Fo ± 4.3 MHz	Digital output power (rms) without Filter ISDB-T	Nominal analog output power (p.s.) ATV
SDT 201UB ARK-6 HE	UHF	AB	1 + 3 RU (19" rack), 400 mm	1	-	7/16"	Air	-	-39	150 W	450 W
SDT 201UB ARK-6	UHF	AB	1 + 3 RU (19" rack), 400 mm	1	-	7/16"	Air	-	-36	80 W	250 W
SDT 201TB ARK-6	VHF (III)	AB	1 + 3 RU (19" rack), 400 mm	1	-	7/16"	Air	-	-36	80 W	250 W

Specifications and characteristics are subject to change without notice.



GUI, modulation page.



GUI, main page.



GUI, input page.

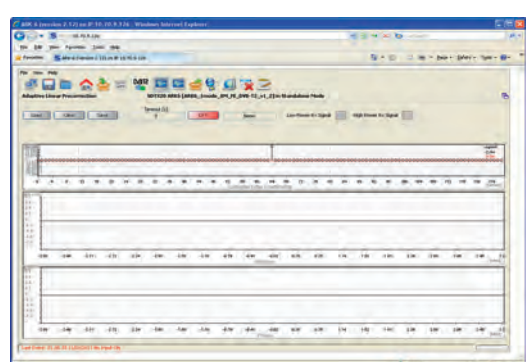

GUI, linear pre correction page.

Heterodyne Transposer, Regenerative Transmitter, Transmitter up to 800W ps/300W rms



> SDT 501 ARK-6

Description

The New SDT ARK-6 Series is the result of years of research and represents the state of the art of the worldwide transmitter technology.

We call it UNIVERSAL DRIVER because of its incredible capability to be all configurations with one hardware and uploading a proper software package.

It is perfect for both international broadcasters which have business in several countries – to increase manageability of investment through reduction of transmitter types – and national broadcasters, due for its versatility in operation modes and configuration. In fact it can be used as a transmitter, a heterodyne transposer, a regenerative transmitter, all in a single hardware.

ARK-6 UNIVERSAL DRIVER is resilient to future evolutions of technology and standardization: this DRIVER guarantees a perfect upgrade path for new modulation schemes that the researchers will delivery.

Besides ARK-6 UNIVERSAL DRIVER already implements DVB-T/T2, ATSC/MH, ISDB-T, DTMB, ATV modulations.

The SDT ARK-6 allows selection of transmission modes in various ways: remotely, using a dry contact; via SNMP commands; via TCP/IP, using the Web graphic interface; or even via a dedicated command inserted into the transport stream.

Functional interfaces are available for total remote control of the apparatus by means of serial protocols or TCP/IP ports. Thanks to the internal Web server the apparatus can be easily monitored and configured and updated using a LAN connection and a standard Web browser. More over, the built-in SNMP agent allows full automated remote control.

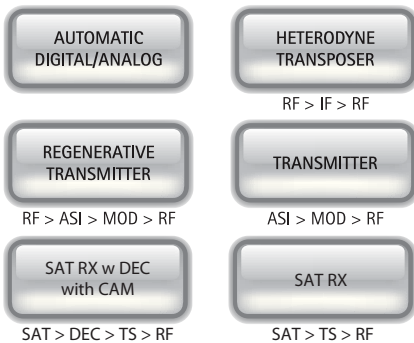

Main Features

- Transmission in VHF and UHF bands
- MFN and SFN operations
- Internal GPS receiver
- Embedded HTTP server
- RF main and monitoring outputs
- Linear and Non-Linear Adaptive digital pre-correction circuits, when operated as transmitter
- Linear and non-linear digital pre-correction circuits, when operated as repeater
- T2-MI input over IP or ASI
- Modulated DVB-T2 RF signal input (VHF/UHF) – when operating as repeater
- T2-MI input RF signal (VHF/UHF) – specific for SFN gap filler operation
- Signal modulation compliant with ETSI EN-302 755 (DVB-T2) standard 1.3.1
- ETSI EN 300 744 v16.1
- ETSI TS 101 191 v1.4.1
- ETSI EN-102 773 (T2-MI)
- ITU -R BT. 470-7
- Full support of T2 modulation up to 256-QAM including I/Q rotation
- T2-MI compliant with standard
- Full Single-PLP and MPLP compatibility (including MISO and PAPR reduction)
- Up to 16 PLP
- Bit rate adaptation plus PCR restamping in S-PLP

Option Features

Based on Software Defined Technology (SWDT), ARK6 T2 Modulator allows the definition of different operative modes on the same hardware platform.



SDT SERIES ARK-6 ISDB-T + ATV

The New SDT ARK-6 SERIES is available in different hardware configurations.



Front View. Transposer and Transmitter Version



Front View. Version with Analog Audio/Video Input



Front View. Transmitter with DVB-S2 Receiver Version



Front View. Transmitter with DVB-S2 Receiver Version with CAM



Front View. Transmitter Version

General Specifications	
Cooling System	Forced air/liquid cooling
Local control and monitoring	Extensive front panel control Local terminal on RS-232
Remote control and monitoring	Web based Java Interface Telnet access via Ethernet SNMP
Operating Temperature	-10°C to +45°C
Maximum relative humidity	90%, non condensing
Maximum operating altitude	2500 m a.s.l. (> 2500 m on request)
Mains power supply	90-260 VAC, 380 VAC (3 Phases) other available on request

MODEL SPECIFIC DATA

Models	Output Band	Working Class	Dimensions	N. Ampl	kind of Ampl	Output Connector	Cooling	Meter board N.	Shoulders @ Fo ± 4.3 MHz	Digital output power (rms) without Filter ISDB-T	Nominal analog output power (p.s.) ATV
SDT 501UB ARK-6 HE C	UHF	AB	3 RU (19" rack), 400 mm	1	-	7/16"	Air	-	-39	300 W	800 W
SDT 501UB ARK-6 C	UHF	AB	3 RU (19" rack), 400 mm	1	-	7/16"	Air	-	-36	150 W	700 W
SDT 501TB ARK-6 C	VHF (III)	AB	3 RU (19" rack), 400 mm	1	-	7/16"	Air	-	-36	150 W	700 W

Specifications and characteristics are subject to change without notice.

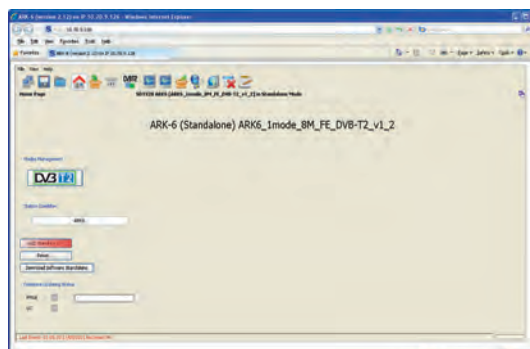

GUI, modulation page.

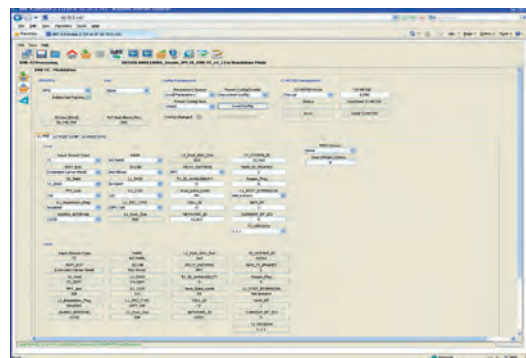

GUI, main page.



GUI, input page.

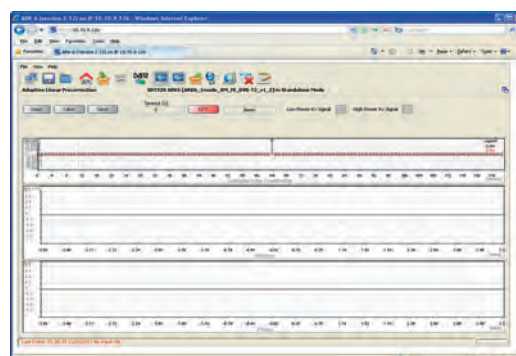

GUI, linear pre correction page.

Heterodyne Transposer, Regenerative Transmitter, Transmitter up to 1000W ps/350W rms



> SDT 501 ARK-6

Description

The New SDT ARK-6 Series is the result of years of research and represents the state of the art of the worldwide transmitter technology.

We call it UNIVERSAL DRIVER because of its incredible capability to be all configurations with one hardware and uploading a proper software package.

It is perfect for both international broadcasters which have business in several countries – to increase manageability of investment through reduction of transmitter types – and national broadcasters, due to its versatility in operation modes and configuration. In fact it can be used as a transmitter, a heterodyne transposer, a regenerative transmitter, all in a single hardware.

ARK-6 UNIVERSAL DRIVER is resilient to future evolutions of technology and standardization: this DRIVER guarantees a perfect upgrade path for new modulation schemes that the researchers will delivery.

Besides ARK-6 UNIVERSAL DRIVER already implements DVB-T/T2, ATSC/MH, ISDB-T, DTMB, ATV modulations.

The SDT ARK-6 allows selection of transmission modes in various ways: remotely, using a dry contact; via SNMP commands; via TCP/IP, using the Web graphic interface; or even via a dedicated command inserted into the transport stream.

Functional interfaces are available for total remote control of the apparatus by means of serial protocols or TCP/IP ports. Thanks to the internal Web server the apparatus can be easily monitored and configured and updated using a LAN connection and a standard Web browser. More over, the built-in SNMP agent allows full automated remote control.

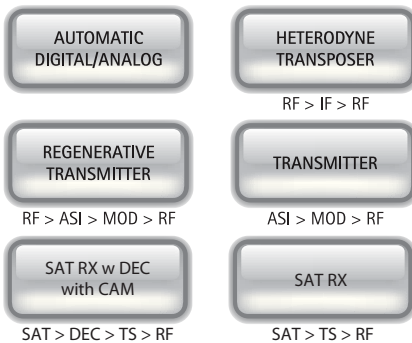

Main Features

- Transmission in VHF and UHF bands
- MFN and SFN operations
- Internal GPS receiver
- Embedded HTTP server
- RF main and monitoring outputs
- Linear and Non-Linear Adaptive digital pre-correction circuits, when operated as transmitter
- Linear and non-linear digital pre-correction circuits, when operated as repeater
- T2-MI input over IP or ASI
- Modulated DVB-T2 RF signal input (VHF/UHF) – when operating as repeater
- T2-MI input RF signal (VHF/UHF) – specific for SFN gap filler operation
- Signal modulation compliant with ETSI EN-302 755 (DVB-T2) standard 1.3.1
- ETSI EN 300 744 v16.1
- ETSI TS 101 191 v1.4.1
- ETSI EN-102 773 (T2-MI)
- ITU -R BT. 470-7
- Full support of T2 modulation up to 256-QAM including I/Q rotation
- T2-MI compliant with standard
- Full Single-PLP and MPLP compatibility (including MISO and PAPR reduction)
- Up to 16 PLP
- Bit rate adaptation plus PCR restamping in S-PLP

Option Features

Based on Software Defined Technology (SWDT), ARK6 T2 Modulator allows the definition of different operative modes on the same hardware platform.



SDT SERIES ARK-6 ISDB-T + ATV

The New SDT ARK-6 SERIES is available in different hardware configurations.



Front View. Transposer and Transmitter Version



Front View. Version with Analog Audio/Video Input



Front View. Transmitter with DVB-S2 Receiver Version



Front View. Transmitter with DVB-S2 Receiver Version with CAM



Front View. Transmitter Version

General Specifications	
Cooling System	Forced air/liquid cooling
Local control and monitoring	Extensive front panel control Local terminal on RS-232
Remote control and monitoring	Web based Java Interface Telnet access via Ethernet SNMP
Operating Temperature	-10°C to +45°C
Maximum relative humidity	90%, non condensing
Maximum operating altitude	2500 m a.s.l. (> 2500 m on request)
Mains power supply	90-260 VAC, 380 VAC (3 Phases) other available on request

MODEL SPECIFIC DATA											
Models	Output Band	Working Class	Dimensions	N. Ampl	kind of Ampl	Output Connector	Cooling	Meter board N.	Shoulders @ Fo ± 4.3 MHz	Digital output power (rms) without Filter ISDB-T	Nominal analog output power (p.s.) ATV
SDT 501UB ARK-6 HE	UHF	AB	15 RU (4+1)	1	SCA501	7/16"	Air	-	-39	350 W	1000 W
SDT 501UB ARK-6	UHF	AB	15 RU (4+1)	1	SCA501	7/16"	Air	-	-36	150 W	700 W
SDT 501TB ARK-6	VHF (III)	AB	15 RU (4+1)	1	SCA501	7/16"	Air	-	-36	150 W	700 W

Specifications and characteristics are subject to change without notice.

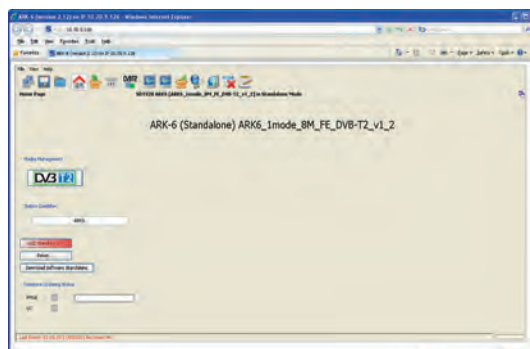

GUI, modulation page.

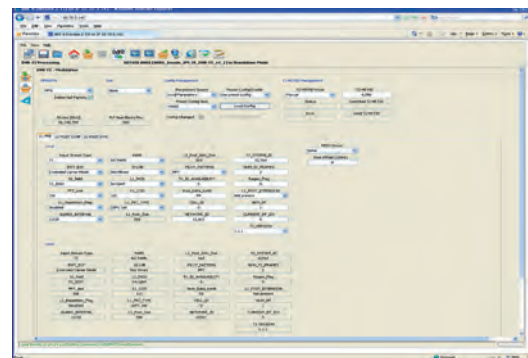

GUI, main page.



GUI, input page.

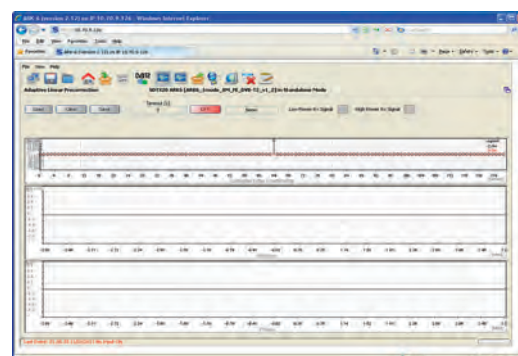

GUI, linear pre correction page.

Heterodyne Transposer, Regenerative Transmitter, Transmitter up to 2000W ps/700W rms



> SDT 102 ARK-6

Description

The New SDT ARK-6 Series is the result of years of research and represents the state of the art of the worldwide transmitter technology.

We call it UNIVERSAL DRIVER because of its incredible capability to be all configurations with one hardware and uploading a proper software package.

It is perfect for both international broadcasters which have business in several countries – to increase manageability of investment through reduction of transmitter types – and national broadcasters, due for its versatility in operation modes and configuration. In fact it can be used as a transmitter, a heterodyne transposer, a regenerative transmitter, all in a single hardware.

ARK-6 UNIVERSAL DRIVER is resilient to future evolutions of technology and standardization: this DRIVER guarantees a perfect upgrade path for new modulation schemes that the researchers will delivery.

Besides ARK-6 UNIVERSAL DRIVER already implements DVB-T/T2, ATSC/MH, ISDB-T, DTMB, ATV modulations.

The SDT ARK-6 allows selection of transmission modes in various ways: remotely, using a dry contact; via SNMP commands; via TCP/IP, using the Web graphic interface; or even via a dedicated command inserted into the transport stream.

Functional interfaces are available for total remote control of the apparatus by means of serial protocols or TCP/IP ports. Thanks to the internal Web server the apparatus can be easily monitored and configured and updated using a LAN connection and a standard Web browser. More over, the built-in SNMP agent allows full automated remote control.

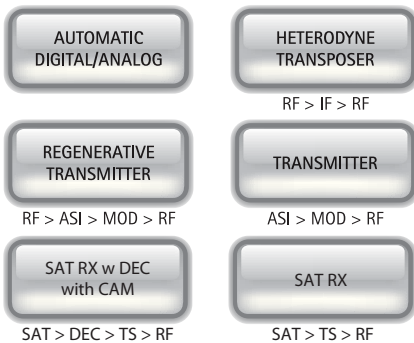

Main Features

- Transmission in VHF and UHF bands
- MFN and SFN operations
- Internal GPS receiver
- Embedded HTTP server
- RF main and monitoring outputs
- Linear and Non-Linear Adaptive digital pre-correction circuits, when operated as transmitter
- Linear and non-linear digital pre-correction circuits, when operated as repeater
- T2-MI input over IP or ASI
- Modulated DVB-T2 RF signal input (VHF/UHF) – when operating as repeater
- T2-MI input RF signal (VHF/UHF) – specific for SFN gap filler operation
- Signal modulation compliant with ETSI EN-302 755 (DVB-T2) standard 1.3.1
- ETSI EN 300 744 v16.1
- ETSI TS 101 191 v1.4.1
- ETSI EN-102 773 (T2-MI)
- ITU -R BT. 470-7
- Full support of T2 modulation up to 256-QAM including I/Q rotation
- T2-MI compliant with standard
- Full Single-PLP and MPLP compatibility (including MISO and PAPR reduction)
- Up to 16 PLP
- Bit rate adaptation plus PCR restamping in S-PLP

Option Features

Based on Software Defined Technology (SWDT), ARK6 T2 Modulator allows the definition of different operative modes on the same hardware platform.



SDT SERIES ARK-6 ISDB-T + ATV

The New SDT ARK-6 SERIES is available in different hardware configurations.



Front View. Transposer and Transmitter Version



Front View. Version with Analog Audio/Video Input



Front View. Transmitter with DVB-S2 Receiver Version



Front View. Transmitter with DVB-S2 Receiver Version with CAM



Front View. Transmitter Version

General Specifications	
Cooling System	Forced air/liquid cooling
Local control and monitoring	Extensive front panel control Local terminal on RS-232
Remote control and monitoring	Web based Java Interface Telnet access via Ethernet SNMP
Operating Temperature	-10°C to +45°C
Maximum relative humidity	90%, non condensing
Maximum operating altitude	2500 m a.s.l. (> 2500 m on request)
Mains power supply	90-260 VAC, 380 VAC (3 Phases) other available on request

MODEL SPECIFIC DATA

Models	Output Band	Working Class	Dimensions	N. Ampl	kind of Ampl	Output Connector	Cooling	Meter board N.	Shoulders @ Fo ± 4.3 MHz	Digital output power (rms) without Filter ISDB-T	Nominal analog output power (p.s.) ATV
SDT 102UB ARK-6 HE	UHF	AB	1+5 RU	1	SCA102HE	7/16"	Air	-	-39	700 W	2000 W
SDT 102UM ARK-6 HE	UHF	AB	30 RU	2	SDT501HE	7/16"	Air	-	-39	700 W	2000 W
SDT 102UB ARK-6	UHF	AB	1+5 RU	1	SCA102UB	7/16"	Air	-	-36	300 W	1400 W
SDT 102UM ARK-6	UHF	AB	30RU	2	SCA501UB	7/16"	Air	-	-36	300 W	1400 W
SDT 102TB ARK-6	VHF (III)	AB	1+5 RU	1	SCA102TB	7/16"	Air	-	-36	300 W	1400 W
SDT 102TM ARK-6	VHF (III)	AB	30 RU	2	SCA501TB	7/16"	Air	-	-36	300 W	1400 W

Specifications and characteristics are subject to change without notice.

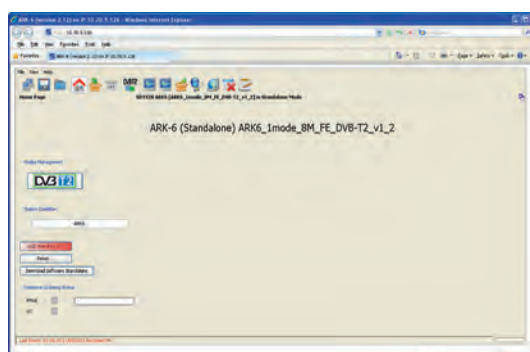

GUI, modulation page.



GUI, main page.



GUI, input page.

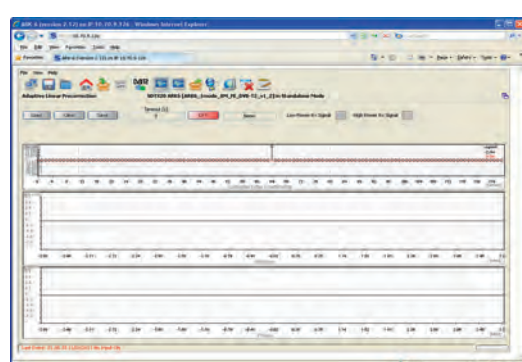

GUI, linear pre correction page.

Heterodyne Transposer, Regenerative Transmitter, Transmitter up to 3000W ps/1300W rms



> SDT 202 ARK-6

Description

The New SDT ARK-6 Series is the result of years of research and represents the state of the art of the worldwide transmitter technology.

We call it UNIVERSAL DRIVER because of its incredible capability to be all configurations with one hardware and uploading a proper software package.

It is perfect for both international broadcasters which have business in several countries – to increase manageability of investment through reduction of transmitter types – and national broadcasters, due for its versatility in operation modes and configuration. In fact it can be used as a transmitter, a heterodyne transposer, a regenerative transmitter, all in a single hardware.

ARK-6 UNIVERSAL DRIVER is resilient to future evolutions of technology and standardization: this DRIVER guarantees a perfect upgrade path for new modulation schemes that the researchers will delivery.

Besides ARK-6 UNIVERSAL DRIVER already implements DVB-T/T2, ATSC/MH, ISDB-T, DTMB, ATV modulations.

The SDT ARK-6 allows selection of transmission modes in various ways: remotely, using a dry contact; via SNMP commands; via TCP/IP, using the Web graphic interface; or even via a dedicated command inserted into the transport stream.

Functional interfaces are available for total remote control of the apparatus by means of serial protocols or TCP/IP ports. Thanks to the internal Web server the apparatus can be easily monitored and configured and updated using a LAN connection and a standard Web browser. More over, the built-in SNMP agent allows full automated remote control.

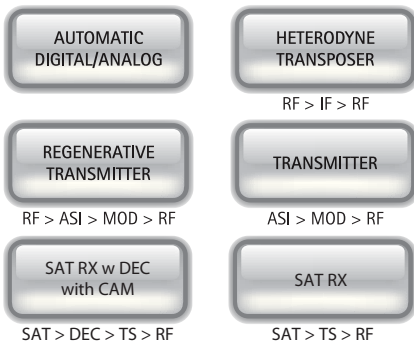

Main Features

- Transmission in VHF and UHF bands
- MFN and SFN operations
- Internal GPS receiver
- Embedded HTTP server
- RF main and monitoring outputs
- Linear and Non-Linear Adaptive digital pre-correction circuits, when operated as transmitter
- Linear and non-linear digital pre-correction circuits, when operated as repeater
- T2-MI input over IP or ASI
- Modulated DVB-T2 RF signal input (VHF/UHF) – when operating as repeater
- T2-MI input RF signal (VHF/UHF) – specific for SFN gap filler operation
- Signal modulation compliant with ETSI EN-302 755 (DVB-T2) standard 1.3.1
- ETSI EN 300 744 v16.1
- ETSI TS 101 191 v1.4.1
- ETSI EN-102 773 (T2-MI)
- ITU -R BT. 470-7
- Full support of T2 modulation up to 256-QAM including I/Q rotation
- T2-MI compliant with standard
- Full Single-PLP and MPLP compatibility (including MISO and PAPR reduction)
- Up to 16 PLP
- Bit rate adaptation plus PCR restamping in S-PLP

Option Features

Based on Software Defined Technology (SWDT), ARK6 T2 Modulator allows the definition of different operative modes on the same hardware platform.



SDT SERIES ARK-6 ISDB-T + ATV

The New SDT ARK-6 SERIES is available in different hardware configurations.



Front View. Transposer and Transmitter Version



Front View. Version with Analog Audio/Video Input



Front View. Transmitter with DVB-S2 Receiver Version



Front View. Transmitter with DVB-S2 Receiver Version with CAM



Front View. Transmitter Version

General Specifications	
Cooling System	Forced air/liquid cooling
Local control and monitoring	Extensive front panel control Local terminal on RS-232
Remote control and monitoring	Web based Java Interface Telnet access via Ethernet SNMP
Operating Temperature	-10°C to +45°C
Maximum relative humidity	90%, non condensing
Maximum operating altitude	2500 m a.s.l. (> 2500 m on request)
Mains power supply	90-260 VAC, 380 VAC (3 Phases) other available on request

MODEL SPECIFIC DATA

Models	Output Band	Working Class	Dimensions	N. Ampl	kind of Ampl	Output Connector	Cooling	Meter board N.	Shoulders @ Fo ± 4.3 MHz	Digital output power (rms) without Filter ISDB-T	Nominal analog output power (p.s.) ATV
SDT 202UB ARK-6 HE	UHF	AB	1+5 RU	1	SCA202HE	7/8"	Air	-	-39	1300 W	3000 W
SDT 202UM ARK-6 HE	UHF	AB	30 RU	2	SCA202HE	7/8"	Air	-	-39	1300 W	3000 W
SDT 202UB ARK-6	UHF	AB	1+5 RU	1	SCA202UB	7/8"	Air	-	-36	700 W	2800 W
SDT 202UM ARK-6	UHF	AB	30RU	2	SCA202UB	7/8"	Air	-	-36	700 W	2800 W
SDT 202TB ARK-6	VHF (III)	AB	1+5 RU	1	SCA202TB	7/8"	Air	-	-36	700 W	2800 W
SDT 202TM ARK-6	VHF (III)	AB	30 RU	2	SCA202TB	7/8"	Air	-	-36	700 W	2800 W

Specifications and characteristics are subject to change without notice.

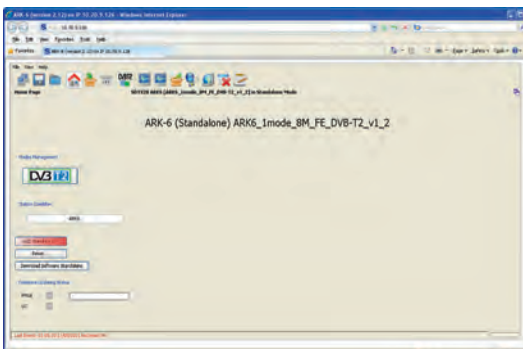

GUI, modulation page.

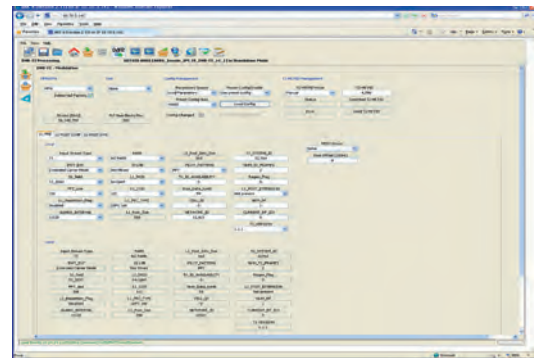

GUI, main page.



GUI, input page.

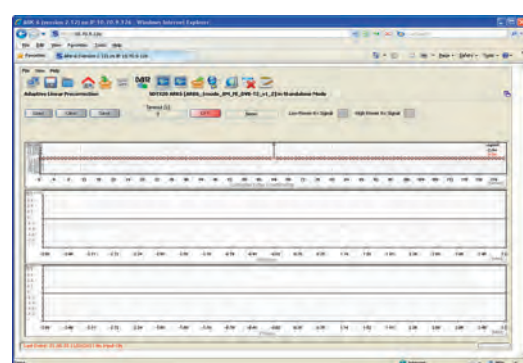

GUI, linear pre correction page.

Heterodyne Transposer, Regenerative Transmitter, Transmitter up to 6000W ps/2600W rms



> SDT 502 ARK-6

Version with
Dual Driver Option
AUTOMATIC
DIGITAL/ANALOG

REGENERATIVE
TRANSMITTER

RF > ASI > MOD > RF

SAT RX w DEC
with CAM

SAT > DEC > TS > RF

> SDT 502 ARK-6

Liquid Cooled - Version
with Dual Driver Option
HETERODYNE
TRANSPOSER

RF > IF > RF

TRANSMITTER

ASI > MOD > RF

SAT RX

SAT > TS > RF



Description

The New SDT ARK-6 Series is the result of years of research and represents the state of the art of the worldwide transmitter technology.

We call it UNIVERSAL DRIVER because of its incredible capability to be all configurations with one hardware and uploading a proper software package.

It is perfect for both international broadcasters which have business in several countries – to increase manageability of investment through reduction of transmitter types – and national broadcasters, due to its versatility in operation modes and configuration. In fact it can be used as a transmitter, a heterodyne transposer, a regenerative transmitter, all in a single hardware.

ARK-6 UNIVERSAL DRIVER is resilient to future evolutions of technology and standardization: this DRIVER guarantees a perfect upgrade path for new modulation schemes that the researchers will delivery.

Besides ARK-6 UNIVERSAL DRIVER already implements DVB-T/T2, ATSC/MH, ISDB-T, DTMB, ATV modulations.

The SDT ARK-6 allows selection of transmission modes in various ways: remotely, using a dry contact; via SNMP commands; via TCP/IP, using the Web graphic interface; or even via a dedicated command inserted into the transport stream.

Functional interfaces are available for total remote control of the apparatus by means of serial protocols or TCP/IP ports. Thanks to the internal Web server the apparatus can be easily monitored and configured and updated using a LAN connection and a standard Web browser. More over, the built-in SNMP agent allows full automated remote control.

Main Features

- Transmission in VHF and UHF bands
- MFN and SFN operations
- Internal GPS receiver
- Embedded HTTP server
- RF main and monitoring outputs
- Linear and Non-Linear Adaptive digital pre-correction circuits, when operated as transmitter
- Linear and non-linear digital pre-correction circuits, when operated as repeater
- T2-MI input over IP or ASI
- Modulated DVB-T2 RF signal input (VHF/UHF) – when operating as repeater
- T2-MI input RF signal (VHF/UHF) – specific for SFN gap filler operation
- Signal modulation compliant with ETSI EN-302 755 (DVB-T2) standard 1.3.1
- ETSI EN 300 744 v16.1
- ETSI TS 101 191 v1.4.1
- ETSI EN-102 773 (T2-MI)
- ITU -R BT. 470-7
- Full support of T2 modulation up to 256-QAM including I/Q rotation
- T2-MI compliant with standard
- Full Single-PLP and MPLP compatibility (including MISO and PAPR reduction)
- Up to 16 PLP
- Bit rate adaptation plus PCR restamping in S-PLP

Option Features

Based on Software Defined Technology (SWDT), ARK6 T2 Modulator allows the definition of different operative modes on the same hardware platform.



SDT SERIES ARK-6 ISDB-T + ATV

The New SDT ARK-6 SERIES is available in different hardware configurations.



Front View. Transposer and Transmitter Version



Front View. Version with Analog Audio/Video Input



Front View. Transmitter with DVB-S2 Receiver Version



Front View. Transmitter with DVB-S2 Receiver Version with CAM



Front View. Transmitter Version

General Specifications	
Cooling System	Forced air/liquid cooling
Local control and monitoring	Extensive front panel control Local terminal on RS-232
Remote control and monitoring	Web based Java Interface Telnet access via Ethernet SNMP
Operating Temperature	-10°C to +45°C
Maximum relative humidity	90%, non condensing
Maximum operating altitude	2500 m a.s.l. (> 2500 m on request)
Mains power supply	90-260 VAC, 380 VAC (3 Phases) other available on request

MODEL SPECIFIC DATA

Models	Output Band	Working Class	Dimensions	N. Ampl	kind of Ampl	Output Connector	Cooling	Meter board N.	Shoulders @ Fo ± 4.3 MHz	Digital output power (rms) without Filter ISDB-T	Nominal analog output power (p.s.) ATV
SDT 502UB ARK-6 HE	UHF	AB	30 RU	2	SCA202HE	1+5/8"	Air	1	-39	2600 W	6000 W
SDT 502UM ARK-6 HE	UHF	AB	40 RU	4	SCA102HE	1+5/8"	Air	1	-39	2600 W	6000 W
SDT 502UB-W ARK-6 HE	UHF	AB	40 RU	2	SCA202HE-W	1+5/8"	Liquid	1	-39	2600 W	6000 W
SDT502UB ARK-6	UHF	AB	30 RU	2	SCA202UB	1+5/8"	Air	1	-36	1300 W	5000 W
SDT502UB-W ARK-6	UHF	AB	40 RU	2	SCA202UB-W	1+5/8"	Liquid	1	-36	1300 W	5000 W
SDT 502UM ARK-6	UHF	AB	40 RU	4	SCA102UB	1+5/8"	Air	1	-36	1300 W	5000 W
SDT 502TB ARK-6	VHF (III)	AB	30 RU	2	SCA202TB	1+5/8"	Air	1	-36	1300 W	5000 W
SDT 502TB-W ARK-6	VHF (III)	AB	40 RU	2	SCA202TB-W	1+5/8"	Liquid	1	-36	1300 W	5000 W
SDT 502TM ARK-6	VHF (III)	AB	40 RU	4	SCA102TB	1+5/8"	Air	1	-36	1300 W	5000 W

Specifications and characteristics are subject to change without notice.

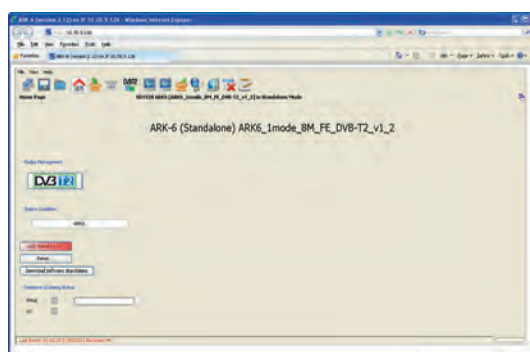

GUI, modulation page.



GUI, main page.



GUI, input page.

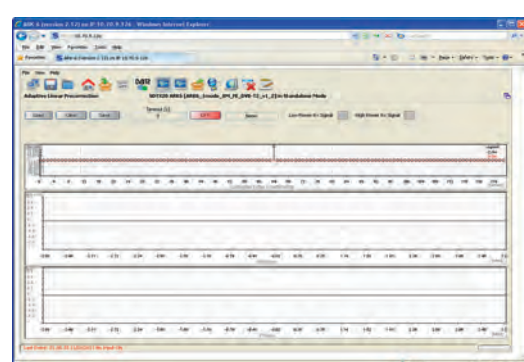

GUI, linear pre correction page.

Heterodyne Transposer, Regenerative Transmitter, Transmitter up to 9000W ps/3900W rms



> SDT 532 ARK-6

Liquid Cooled Version with
AD Converter Option
DIGITAL/ANALOG

HETERODYNE
TRANSPOSER

RF > IF > RF

REGENERATIVE
TRANSMITTER

RF > ASI > MOD > RF

TRANSMITTER

ASI > MOD > RF

SAT RX w DEC
with CAM

SAT > DEC > TS > RF

SAT RX

SAT > TS > RF

ATV

DVB T

DVB H

DVB T2

ATSC

at s c
MOBILE DTV

ISDB-T

DTMB

Description

The New SDT ARK-6 Series is the result of years of research and represents the state of the art of the worldwide transmitter technology.

We call it UNIVERSAL DRIVER because of its incredible capability to be all configurations with one hardware and uploading a proper software package.

It is perfect for both international broadcasters which have business in several countries – to increase manageability of investment through reduction of transmitter types – and national broadcasters, due for its versatility in operation modes and configuration. In fact it can be used as a transmitter, a heterodyne transposer, a regenerative transmitter, all in a single hardware.

ARK-6 UNIVERSAL DRIVER is resilient to future evolutions of technology and standardization: this DRIVER guarantees a perfect upgrade path for new modulation schemes that the researchers will delivery.

Besides ARK-6 UNIVERSAL DRIVER already implements DVB-T/T2, ATSC/MH, ISDB-T, DTMB, ATV modulations.

The SDT ARK-6 allows selection of transmission modes in various ways: remotely, using a dry contact; via SNMP commands; via TCP/IP, using the Web graphic interface; or even via a dedicated command inserted into the transport stream.

Functional interfaces are available for total remote control of the apparatus by means of serial protocols or TCP/IP ports. Thanks to the internal Web server the apparatus can be easily monitored and configured and updated using a LAN connection and a standard Web browser. More over, the built-in SNMP agent allows full automated remote control.

Main Features

- Transmission in VHF and UHF bands
- MFN and SFN operations
- Internal GPS receiver
- Embedded HTTP server
- RF main and monitoring outputs
- Linear and Non-Linear Adaptive digital pre-correction circuits, when operated as transmitter
- Linear and non-linear digital pre-correction circuits, when operated as repeater
- T2-MI input over IP or ASI
- Modulated DVB-T2 RF signal input (VHF/UHF) – when operating as repeater
- T2-MI input RF signal (VHF/UHF) – specific for SFN gap filler operation
- Signal modulation compliant with ETSI EN-302 755 (DVB-T2) standard 1.3.1
- ETSI EN 300 744 v16.1
- ETSI TS 101 191 v1.4.1
- ETSI EN-102 773 (T2-MI)
- ITU -R BT. 470-7
- Full support of T2 modulation up to 256-QAM including I/Q rotation
- T2-MI compliant with standard
- Full Single-PLP and MPLP compatibility (including MISO and PAPR reduction)
- Up to 16 PLP
- Bit rate adaptation plus PCR restamping in S-PLP

Option Features

Based on Software Defined Technology (SWDT), ARK6 T2 Modulator allows the definition of different operative modes on the same hardware platform.



SDT SERIES ARK-6 ISDB-T + ATV

The New SDT ARK-6 SERIES is available in different hardware configurations.



Front View. Transposer and Transmitter Version



Front View. Version with Analog Audio/Video Input



Front View. Transmitter with DVB-S2 Receiver Version



Front View. Transmitter with DVB-S2 Receiver Version with CAM



Front View. Transmitter Version

General Specifications	
Cooling System	Forced air/liquid cooling
Local control and monitoring	Extensive front panel control Local terminal on RS-232
Remote control and monitoring	Web based Java Interface Telnet access via Ethernet SNMP
Operating Temperature	-10°C to +45°C
Maximum relative humidity	90%, non condensing
Maximum operating altitude	2500 m a.s.l. (> 2500 m on request)
Mains power supply	90-260 VAC, 380 VAC (3 Phases) other available on request

MODEL SPECIFIC DATA

Models	Output Band	Working Class	Dimensions	N. Ampl	kind of Ampl	Output Connector	Cooling	Meter board N.	Shoulders @ Fo ± 4.3 MHz	Digital output power (rms) without Filter ISDB-T	Nominal analog output power (p.s.) ATV
SDT 532UB-W ARK-6 HE	UHF	AB	40 RU	3	SCA202HE-W	1+5/8"	Liquid	1	-39	3900 W	9000 W
SDT 532UB-W ARK-6	UHF	AB	40 RU	3	SCA202UB-W	1+5/8"	Liquid	1	-36	2000 W	7500 W
SDT 532TB-W ARK-6	VHF (III)	AB	40 RU	3	SCA202TB-W	1+5/8"	Liquid	1	-36	2000 W	7500 W

Specifications and characteristics are subject to change without notice.

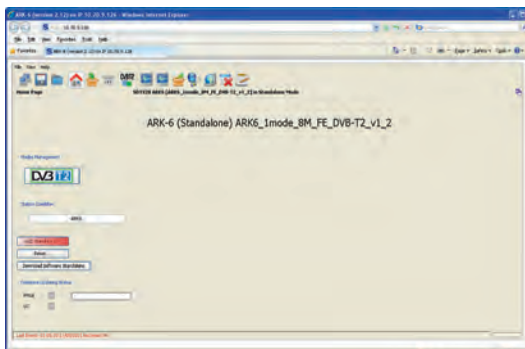

GUI, modulation page.

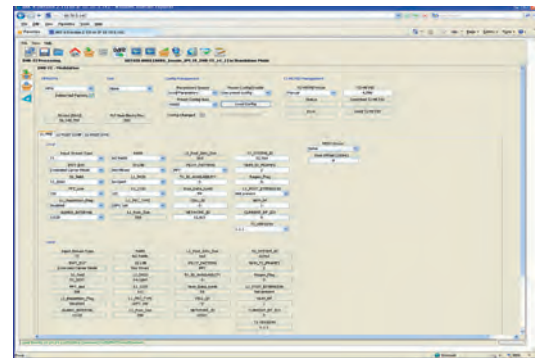

GUI, main page.



GUI, input page.



GUI, linear pre correction page.

Heterodyne Transposer, Regenerative Transmitter, Transmitter up to 12000W ps/5200W rms



Description

The New SDT ARK-6 Series is the result of years of research and represents the state of the art of the worldwide transmitter technology.

We call it UNIVERSAL DRIVER because of its incredible capability to be all configurations with one hardware and uploading a proper software package.

It is perfect for both international broadcasters which have business in several countries – to increase manageability of investment through reduction of transmitter types – and national broadcasters, due to its versatility in operation modes and configuration. In fact it can be used as a transmitter, a heterodyne transposer, a regenerative transmitter, all in a single hardware.

ARK-6 UNIVERSAL DRIVER is resilient to future evolutions of technology and standardization: this DRIVER guarantees a perfect upgrade path for new modulation schemes that the researchers will delivery.

Besides ARK-6 UNIVERSAL DRIVER already implements DVB-T/T2, ATSC/MH, ISDB-T, DTMB, ATV modulations.

The SDT ARK-6 allows selection of transmission modes in various ways: remotely, using a dry contact; via SNMP commands; via TCP/IP, using the Web graphic interface; or even via a dedicated command inserted into the transport stream.

Functional interfaces are available for total remote control of the apparatus by means of serial protocols or TCP/IP ports. Thanks to the internal Web server the apparatus can be easily monitored and configured and updated using a LAN connection and a standard Web browser. Moreover, the built-in SNMP agent allows full automated remote control.

> SDT 103 ARK-6

> SDT 103 W ARK-6
Liquid Cooled Version with
Dual Driver Option

AUTOMATIC
DIGITAL/ANALOG

HETERODYNE
TRANSPOSER

RF > IF > RF

REGENERATIVE
TRANSMITTER

TRANSMITTER

RF > ASI > MOD > RF

ASI > MOD > RF

SAT RX w DEC
with CAM

SAT RX

SAT > DEC > TS > RF

SAT > TS > RF



Main Features

- Transmission in VHF and UHF bands
- MFN and SFN operations
- Internal GPS receiver
- Embedded HTTP server
- RF main and monitoring outputs
- Linear and Non-Linear Adaptive digital pre-correction circuits, when operated as transmitter
- Linear and non-linear digital pre-correction circuits, when operated as repeater
- T2-MI input over IP or ASI
- Modulated DVB-T2 RF signal input (VHF/UHF) – when operating as repeater
- T2-MI input RF signal (VHF/UHF) – specific for SFN gap filler operation
- Signal modulation compliant with ETSI EN-302 755 (DVB-T2) standard 1.3.1
- ETSI EN 300 744 v16.1
- ETSI TS 101 191 v1.4.1
- ETSI EN-102 773 (T2-MI)
- ITU -R BT. 470-7
- Full support of T2 modulation up to 256-QAM including I/Q rotation
- T2-MI compliant with standard
- Full Single-PLP and MPLP compatibility (including MISO and PAPR reduction)
- Up to 16 PLP
- Bit rate adaptation plus PCR restamping in S-PLP

Option Features

Based on Software Defined Technology (SWDT), ARK6 T2 Modulator allows the definition of different operative modes on the same hardware platform.



SDT SERIES ARK-6 ISDB-T + ATV

The New SDT ARK-6 SERIES is available in different hardware configurations.



Front View. Transposer and Transmitter Version



Front View. Version with Analog Audio/Video Input



Front View. Transmitter with DVB-S2 Receiver Version



Front View. Transmitter with DVB-S2 Receiver Version with CAM



Front View. Transmitter Version

General Specifications	
Cooling System	Forced air/liquid cooling
Local control and monitoring	Extensive front panel control Local terminal on RS-232
Remote control and monitoring	Web based Java Interface Telnet access via Ethernet SNMP
Operating Temperature	-10°C to +45°C
Maximum relative humidity	90%, non condensing
Maximum operating altitude	2500 m a.s.l. (> 2500 m on request)
Mains power supply	90-260 VAC, 380 VAC (3 Phases) other available on request

MODEL SPECIFIC DATA

Models	Output Band	Working Class	Dimensions	N. Ampl	kind of Ampl	Output Connector	Cooling	Meter board N.	Shoulders @ Fo ± 4.3 MHz	Digital output power (rms) without Filter ISDB-T	Nominal analog output power (p.s.) ATV
SDT 103UM ARK-6 HE	UHF	AB	40 RU	4	SCA202HE	3+1/8"	Air	1	-39	5200 W	12000 W
SDT 103UM-W ARK-6 HE	UHF	AB	40 RU	4	SCA202HE	3+1/8"	Liquid	1	-39	5200 W	12000 W
SDT 103UM ARK-6	UHF	AB	40 RU	4	SCA202UB	3+1/8"	Air	1	-36	2600 W	10000 W
SDT 103UM-W ARK-6	UHF	AB	40 RU	4	SCA202UB-W	3+1/8"	Liquid	1	-36	2600 W	10000 W
SDT 103TM ARK-6	VHF (III)	AB	40 RU	4	SCA202TB	3+1/8"	Air	1	-36	2600 W	10000 W
SDT 103TM-W ARK-6	VHF (III)	AB	40 RU	4	SCA202TB-W	3+1/8"	Liquid	1	-36	2600 W	10000 W

Specifications and characteristics are subject to change without notice.

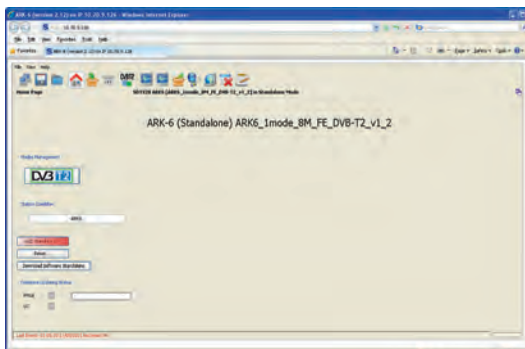

GUI, modulation page.

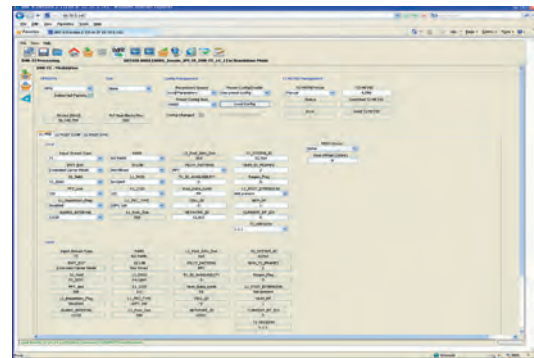

GUI, main page.



GUI, input page.



GUI, linear pre correction page.

Heterodyne Transposer, Regenerative Transmitter, Transmitter up to 12500W ps/3200W rms



> SDT 123UM-W ARK-6
Liquid Cooled Version With Dual Driver

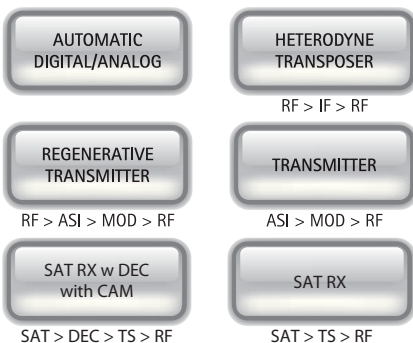

Description

The New SDT ARK-6 Series is the result of years of research and represents the state of the art of the worldwide transmitter technology.

We call it UNIVERSAL DRIVER because of its incredible capability to be all configurations with one hardware and uploading a proper software package.

It is perfect for both international broadcasters which have business in several countries – to increase manageability of investment through reduction of transmitter types – and national broadcasters, due to its versatility in operation modes and configuration. In fact it can be used as a transmitter, a heterodyne transposer, a regenerative transmitter, all in a single hardware.

ARK-6 UNIVERSAL DRIVER is resilient to future evolutions of technology and standardization: this DRIVER guarantees a perfect upgrade path for new modulation schemes that the researchers will delivery.

Besides ARK-6 UNIVERSAL DRIVER already implements DVB-T/T2, ATSC/MH, ISDB-T, DTMB, ATV modulations.

The SDT ARK-6 allows selection of transmission modes in various ways: remotely, using a dry contact; via SNMP commands; via TCP/IP, using the Web graphic interface; or even via a dedicated command inserted into the transport stream.

Functional interfaces are available for total remote control of the apparatus by means of serial protocols or TCP/IP ports. Thanks to the internal Web server the apparatus can be easily monitored and configured and updated using a LAN connection and a standard Web browser. Moreover, the built-in SNMP agent allows full automated remote control.

Main Features

- Transmission in VHF and UHF bands
- MFN and SFN operations
- Internal GPS receiver
- Embedded HTTP server
- RF main and monitoring outputs
- Linear and Non-Linear Adaptive digital pre-correction circuits, when operated as transmitter
- Linear and non-linear digital pre-correction circuits, when operated as repeater
- T2-MI input over IP or ASI
- Modulated DVB-T2 RF signal input (VHF/UHF) – when operating as repeater
- T2-MI input RF signal (VHF/UHF) – specific for SFN gap filler operation
- Signal modulation compliant with ETSI EN-302 755 (DVB-T2) standard 1.3.1
- ETSI EN 300 744 v16.1
- ETSI TS 101 191 v1.4.1
- ETSI EN-102 773 (T2-MI)
- ITU -R BT. 470-7
- Full support of T2 modulation up to 256-QAM including I/Q rotation
- T2-MI compliant with standard
- Full Single-PLP and MPLP compatibility (including MISO and PAPR reduction)
- Up to 16 PLP
- Bit rate adaptation plus PCR restamping in S-PLP

Option Features

Based on Software Defined Technology (SWDT), ARK6 T2 Modulator allows the definition of different operative modes on the same hardware platform.



SDT SERIES ARK-6 ISDB-T + ATV

The New SDT ARK-6 SERIES is available in different hardware configurations.



Front View. Transposer and Transmitter Version



Front View. Version with Analog Audio/Video Input



Front View. Transmitter with DVB-S2 Receiver Version



Front View. Transmitter with DVB-S2 Receiver Version with CAM



Front View. Transmitter Version

General Specifications	
Cooling System	Forced air/liquid cooling
Local control and monitoring	Extensive front panel control Local terminal on RS-232
Remote control and monitoring	Web based Java Interface Telnet access via Ethernet SNMP
Operating Temperature	-10°C to +45°C
Maximum relative humidity	90%, non condensing
Maximum operating altitude	2500 m a.s.l. (> 2500 m on request)
Mains power supply	90-260 VAC, 380 VAC (3 Phases) other available on request

MODEL SPECIFIC DATA

Models	Output Band	Working Class	Dimensions	N. Ampl	kind of Ampl	Output Connector	Cooling	Meter board N.	Shoulders @ Fo ± 4.3 MHz	Digital output power (rms) without Filter ISDB-T	Nominal analog output power (p.s.) ATV
SDT 123UM-W ARK-6	UHF	AB	40 RU	5	SCA202UB-W	3+1/8"	Liquid	1	-36	3200 W	12500 W
SDT 123TM-W ARK-6	VHF (III)	AB	40 RU	5	SCA202TB-W	3+1/8"	Liquid	1	-36	3200 W	12500 W

Specifications and characteristics are subject to change without notice.

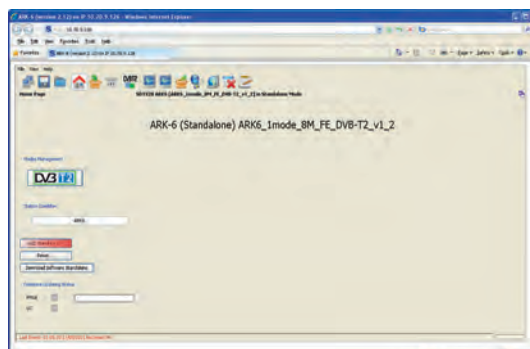

GUI, modulation page.

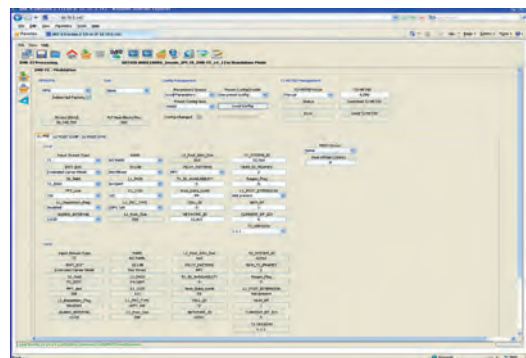

GUI, main page.



GUI, input page.

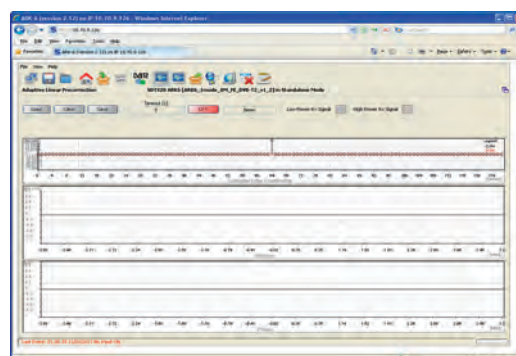

GUI, linear pre correction page.

Heterodyne Transposer, Regenerative Transmitter, Transmitter up to 18000W ps/7800W rms



> SDT 133UM-W ARK-6
Liquid Cooled Version
with Dual Driver Option

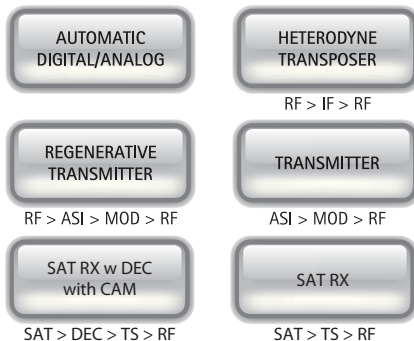

Description

The New SDT ARK-6 Series is the result of years of research and represents the state of the art of the worldwide transmitter technology.

We call it UNIVERSAL DRIVER because of its incredible capability to be all configurations with one hardware and uploading a proper software package.

It is perfect for both international broadcasters which have business in several countries – to increase manageability of investment through reduction of transmitter types – and national broadcasters, due for its versatility in operation modes and configuration. In fact it can be used as a transmitter, a heterodyne transposer, a regenerative transmitter, all in a single hardware. ARK-6 UNIVERSAL DRIVER is resilient to future evolutions of technology and standardization: this DRIVER guarantees a perfect upgrade path for new modulation schemes that the researchers will delivery.

Besides ARK-6 UNIVERSAL DRIVER already implements DVB-T/T2, ATSC/MH, ISDB-T, DTMB, ATV modulations.

The SDT ARK-6 allows selection of transmission modes in various ways: remotely, using a dry contact; via SNMP commands; via TCP/IP, using the Web graphic interface; or even via a dedicated command inserted into the transport stream.

Functional interfaces are available for total remote control of the apparatus by means of serial protocols or TCP/IP ports. Thanks to the internal Web server the apparatus can be easily monitored and configured and updated using a LAN connection and a standard Web browser. More over, the built-in SNMP agent allows full automated remote control.

Main Features

- Transmission in VHF and UHF bands
- MFN and SFN operations
- Internal GPS receiver
- Embedded HTTP server
- RF main and monitoring outputs
- Linear and Non-Linear Adaptive digital pre-correction circuits, when operated as transmitter
- Linear and non-linear digital pre-correction circuits, when operated as repeater
- T2-MI input over IP or ASI
- Modulated DVB-T2 RF signal input (VHF/UHF) – when operating as repeater
- T2-MI input RF signal (VHF/UHF) – specific for SFN gap filler operation
- Signal modulation compliant with ETSI EN-302 755 (DVB-T2) standard 1.3.1
- ETSI EN 300 744 v16.1
- ETSI TS 101 191 v1.4.1
- ETSI EN-102 773 (T2-MI)
- ITU -R BT. 470-7
- Full support of T2 modulation up to 256-QAM including I/Q rotation
- T2-MI compliant with standard
- Full Single-PLP and MPLP compatibility (including MISO and PAPR reduction)
- Up to 16 PLP
- Bit rate adaptation plus PCR restamping in S-PLP

Option Features

Based on Software Defined Technology (SWDT), ARK6 T2 Modulator allows the definition of different operative modes on the same hardware platform.



SDT SERIES ARK-6 ISDB-T + ATV

The New SDT ARK-6 SERIES is available in different hardware configurations.



Front View. Transposer and Transmitter Version



Front View. Version with Analog Audio/Video Input



Front View. Transmitter with DVB-S2 Receiver Version



Front View. Transmitter with DVB-S2 Receiver Version with CAM



Front View. Transmitter Version

General Specifications	
Cooling System	Forced air/liquid cooling
Local control and monitoring	Extensive front panel control Local terminal on RS-232
Remote control and monitoring	Web based Java Interface Telnet access via Ethernet SNMP
Operating Temperature	-10°C to +45°C
Maximum relative humidity	90%, non condensing
Maximum operating altitude	2500 m a.s.l. (> 2500 m on request)
Mains power supply	90-260 VAC, 380 VAC (3 Phases) other available on request

MODEL SPECIFIC DATA

Models	Output Band	Working Class	Dimensions	N. Ampl	kind of Ampl	Output Connector	Cooling	Meter board N.	Shoulders @ $F_o \pm 4.3$ MHz	Digital output power (rms) without Filter ISDB-T	Nominal analog output power (p.s.) ATV
SDT 133UM-W ARK-6 HE	UHF	AB	2 x 40 RU	6	SCA202HE-W	3+1/8"	Liquid	1	-39	7800 W	18000 W
SDT 133UM-W ARK-6	UHF	AB	2 x 40 RU	6	SCA202UB-W	3+1/8"	Liquid	1	-36	6000 W	16000 W
SDT 133TM-W ARK-6	VHF (III)	AB	2 x 40 RU	6	SCA202TB-W	3+1/8"	Liquid	1	-36	6000 W	16000 W

Specifications and characteristics are subject to change without notice.

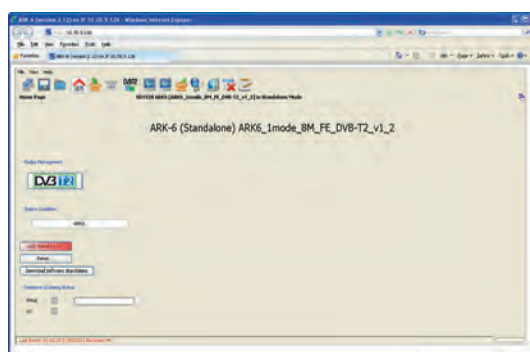

GUI, modulation page.



GUI, main page.



GUI, input page.

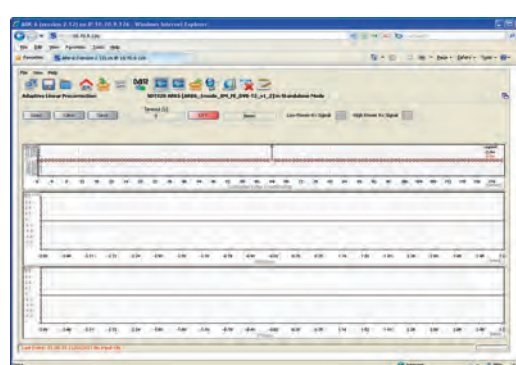

GUI, linear pre correction page.

Heterodyne Transposer, Regenerative Transmitter, Transmitter up to 24000W ps/10000W rms



> SDT 203 ARK-6
With Dual Driver Option



> SDT 203 W ARK-6
Liquid Cooled Version
with Dual Driver Option

Description

The New SDT ARK-6 Series is the result of years of research and represents the state of the art of the worldwide transmitter technology.

We call it UNIVERSAL DRIVER because of its incredible capability to be all configurations with one hardware and uploading a proper software package.

It is perfect for both international broadcasters which have business in several countries – to increase manageability of investment through reduction of transmitter types – and national broadcasters, due for its versatility in operation modes and configuration. In fact it can be used as a transmitter, a heterodyne transposer, a regenerative transmitter, all in a single hardware.

ARK-6 UNIVERSAL DRIVER is resilient to future evolutions of technology and standardization: this DRIVER guarantees a perfect upgrade path for new modulation schemes that the researchers will delivery.

Besides ARK-6 UNIVERSAL DRIVER already implements DVB-T/T2, ATSC/MH, ISDB-T, DTMB, ATV modulations.

The SDT ARK-6 allows selection of transmission modes in various ways: remotely, using a dry contact; via SNMP commands; via TCP/IP, using the Web graphic interface; or even via a dedicated command inserted into the transport stream.

Functional interfaces are available for total remote control of the apparatus by means of serial protocols or TCP/IP ports. Thanks to the internal Web server the apparatus can be easily monitored and configured and updated using a LAN connection and a standard Web browser. More over, the built-in SNMP agent allows full automated remote control.

Main Features

- Transmission in VHF and UHF bands
- MFN and SFN operations
- Internal GPS receiver
- Embedded HTTP server
- RF main and monitoring outputs
- Linear and Non-Linear Adaptive digital pre-correction circuits, when operated as transmitter
- Linear and non-linear digital pre-correction circuits, when operated as repeater
- T2-MI input over IP or ASI
- Modulated DVB-T2 RF signal input (VHF/UHF) – when operating as repeater
- T2-MI input RF signal (VHF/UHF) – specific for SFN gap filler operation
- Signal modulation compliant with ETSI EN-302 755 (DVB-T2) standard 1.3.1
- ETSI EN 300 744 v16.1
- ETSI TS 101 191 v1.4.1
- ETSI EN-102 773 (T2-MI)
- ITU -R BT. 470-7
- Full support of T2 modulation up to 256-QAM including I/Q rotation
- T2-MI compliant with standard
- Full Single-PLP and MPLP compatibility (including MISO and PAPR reduction)
- Up to 16 PLP
- Bit rate adaptation plus PCR restamping in S-PLP

Option Features

Based on Software Defined Technology (SWDT), ARK6 T2 Modulator allows the definition of different operative modes on the same hardware platform.

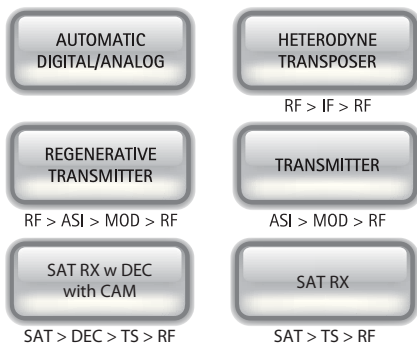

SDT SERIES ARK-6 ISDB-T + ATV

The New SDT ARK-6 SERIES is available in different hardware configurations.



Front View. Transposer and Transmitter Version



Front View. Version with Analog Audio/Video Input



Front View. Transmitter with DVB-S2 Receiver Version



Front View. Transmitter with DVB-S2 Receiver Version with CAM



Front View. Transmitter Version

General Specifications	
Cooling System	Forced air/liquid cooling
Local control and monitoring	Extensive front panel control Local terminal on RS-232
Remote control and monitoring	Web based Java Interface Telnet access via Ethernet SNMP
Operating Temperature	-10°C to +45°C
Maximum relative humidity	90%, non condensing
Maximum operating altitude	2500 m a.s.l. (> 2500 m on request)
Mains power supply	90-260 VAC, 380 VAC (3 Phases) other available on request

MODEL SPECIFIC DATA

Models	Output Band	Working Class	Dimensions	N. Ampl	kind of Ampl	Output Connector	Cooling	Meter board N.	Shoulders @ Fo ± 4.3 MHz	Digital output power (rms) without Filter ISDB-T	Nominal analog output power (p.s.) ATV
SDT 203UM ARK-6 HE	UHF	AB	2 x 40 RU	8	SCA202HE	3+1/8"	Air	2	-39	10000 W	24000 W
SDT 203UM-W ARK-6 HE	UHF	AB	2 x 40 RU	8	SCA202HE	3+1/8"	Liquid	2	-39	10000 W	24000 W
SDT 203UM ARK-6	UHF	AB	2 x 40 RU	8	SCA202UB	3+1/8"	Air	2	-36	5000 W	20000 W
SDT 203UM-W ARK-6	UHF	AB	2 x 40 RU	8	SCA202UB-W	3+1/8"	Liquid	2	-36	5000 W	20000 W
SDT 203TM ARK-6	VHF (III)	AB	2 x 40 RU	8	SCA202TB	3+1/8"	Air	2	-36	5000 W	20000 W
SDT 203TM-W ARK-6	VHF (III)	AB	2 x 40 RU	8	SCA202TB-W	3+1/8"	Liquid	2	-36	5000 W	20000 W

Specifications and characteristics are subject to change without notice.

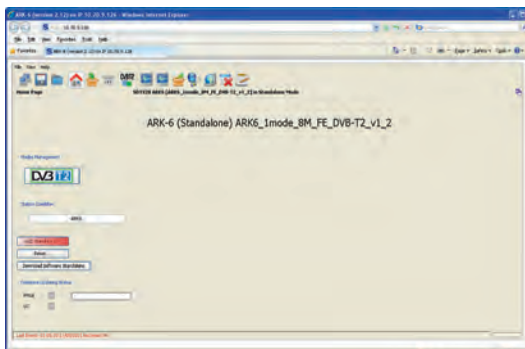

GUI, modulation page.

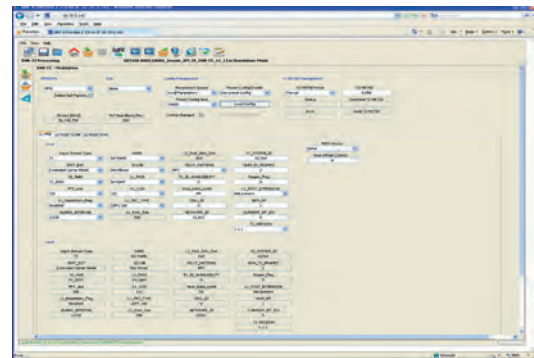

GUI, main page.



GUI, input page.



GUI, linear pre correction page.

Heterodyne Transposer, Regenerative Transmitter, Transmitter up to 36000W ps/15000W rms – Liquid Cooled Version



> SDT 303 ARK-6
With Liquid Cooling and Dual Driver Option

Description

The New SDT ARK-6 Series is the result of years of research and represents the state of the art of the worldwide transmitter technology.

We call it UNIVERSAL DRIVER because of its incredible capability to be all configurations with one hardware and uploading a proper software package.

It is perfect for both international broadcasters which have business in several countries – to increase manageability of investment through reduction of transmitter types – and national broadcasters, due for its versatility in operation modes and configuration. In fact it can be used as a transmitter, a heterodyne transposer, a regenerative transmitter, all in a single hardware.

ARK-6 UNIVERSAL DRIVER is resilient to future evolutions of technology and standardization: this DRIVER guarantees a perfect upgrade path for new modulation schemes that the researchers will delivery.

Besides ARK-6 UNIVERSAL DRIVER already implements DVB-T/T2, ATSC/MH, ISDB-T, DTMB, ATV modulations.

The SDT ARK-6 allows selection of transmission modes in various ways: remotely, using a dry contact; via SNMP commands; via TCP/IP, using the Web graphic interface; or even via a dedicated command inserted into the transport stream.

Functional interfaces are available for total remote control of the apparatus by means of serial protocols or TCP/IP ports. Thanks to the internal Web server the apparatus can be easily monitored and configured and updated using a LAN connection and a standard Web browser. More over, the built-in SNMP agent allows full automated remote control.

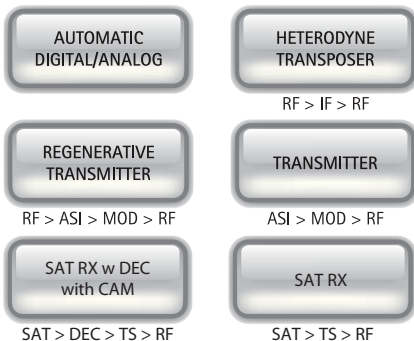

Main Features

- Transmission in VHF and UHF bands
- MFN and SFN operations
- Internal GPS receiver
- Embedded HTTP server
- RF main and monitoring outputs
- Linear and Non-Linear Adaptive digital pre-correction circuits, when operated as transmitter
- Linear and non-linear digital pre-correction circuits, when operated as repeater
- T2-MI input over IP or ASI
- Modulated DVB-T2 RF signal input (VHF/UHF) – when operating as repeater
- T2-MI input RF signal (VHF/UHF) – specific for SFN gap filler operation
- Signal modulation compliant with ETSI EN-302 755 (DVB-T2) standard 1.3.1
- ETSI EN 300 744 v16.1
- ETSI TS 101 191 v1.4.1
- ETSI EN-102 773 (T2-MI)
- ITU -R BT. 470-7
- Full support of T2 modulation up to 256-QAM including I/Q rotation
- T2-MI compliant with standard
- Full Single-PLP and MPLP compatibility (including MISO and PAPR reduction)
- Up to 16 PLP
- Bit rate adaptation plus PCR restamping in S-PLP

Option Features

Based on Software Defined Technology (SWDT), ARK6 T2 Modulator allows the definition of different operative modes on the same hardware platform.



SDT SERIES ARK-6 ISDB-T + ATV

The New SDT ARK-6 SERIES is available in different hardware configurations.



Front View. Transposer and Transmitter Version



Front View. Version with Analog Audio/Video Input



Front View. Transmitter with DVB-S2 Receiver Version



Front View. Transmitter with DVB-S2 Receiver Version with CAM



Front View. Transmitter Version

General Specifications	
Cooling System	Forced air/liquid cooling
Local control and monitoring	Extensive front panel control Local terminal on RS-232
Remote control and monitoring	Web based Java Interface Telnet access via Ethernet SNMP
Operating Temperature	-10°C to +45°C
Maximum relative humidity	90%, non condensing
Maximum operating altitude	2500 m a.s.l. (> 2500 m on request)
Mains power supply	90-260 VAC, 380 VAC (3 Phases) other available on request

MODEL SPECIFIC DATA

Models	Output Band	Working Class	Dimensions	N. Ampl	kind of Ampl	Output Connector	Cooling	Meter board N.	Shoulders @ Fo ± 4.3 MHz	Digital output power (rms) without Filter ISDB-T	Nominal analog output power (p.s.) ATV
SDT 303UM-W ARK-6 HE	UHF	AB	3 X 40 RU	12	SCA202HE-W	4+1/2"	Liquid	4	-39	15000 W	36000 W
SDT 303UM-W ARK-6	UHF	AB	3 X 40 RU	12	SCA202UB-W	4+1/2"	Liquid	4	-36	7800 W	32000 W
SDT 303TM-W ARK-6	VHF (III)	AB	3 X 40 RU	12	SCA202TB-W	4+1/2"	Liquid	4	-36	7800 W	32000 W

Specifications and characteristics are subject to change without notice.

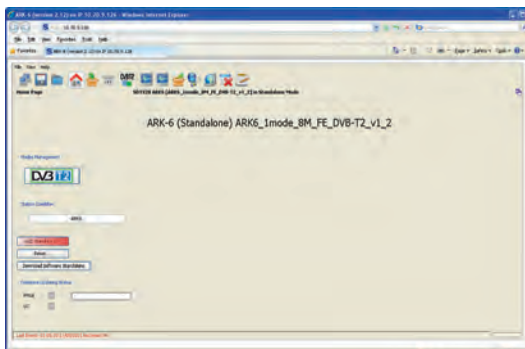

GUI, modulation page.

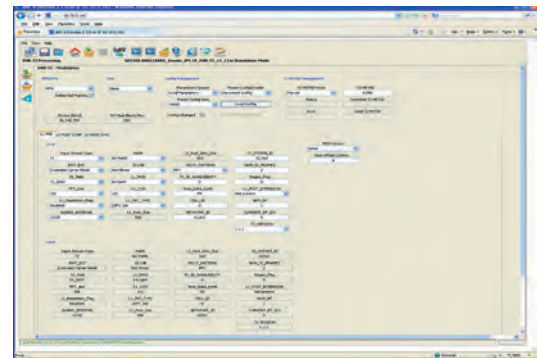

GUI, main page.



GUI, input page.



GUI, linear pre correction page.

Heterodyne Transposer, Regenerative Transmitter, Transmitter up to 48000W ps/20000W rms – Liquid Cooled Version



> SDT 403 ARK-6 W
Liquid Cooled – Version with Dual Driver Option

Description

The New SDT ARK-6 Series is the result of years of research and represents the state of the art of the worldwide transmitter technology.

We call it UNIVERSAL DRIVER because of its incredible capability to be all configurations with one hardware and uploading a proper software package.

It is perfect for both international broadcasters which have business in several countries – to increase manageability of investment through reduction of transmitter types – and national broadcasters, due for its versatility in operation modes and configuration. In fact it can be used as a transmitter, a heterodyne transposer, a regenerative transmitter, all in a single hardware.

ARK-6 UNIVERSAL DRIVER is resilient to future evolutions of technology and standardization: this DRIVER guarantees a perfect upgrade path for new modulation schemes that the researchers will delivery.

Besides ARK-6 UNIVERSAL DRIVER already implements DVB-T/T2, ATSC/MH, ISDB-T, DTMB, ATV modulations.

The SDT ARK-6 allows selection of transmission modes in various ways: remotely, using a dry contact; via SNMP commands; via TCP/IP, using the Web graphic interface; or even via a dedicated command inserted into the transport stream.

Functional interfaces are available for total remote control of the apparatus by means of serial protocols or TCP/IP ports. Thanks to the internal Web server the apparatus can be easily monitored and configured and updated using a LAN connection and a standard Web browser. More over, the built-in SNMP agent allows full automated remote control.

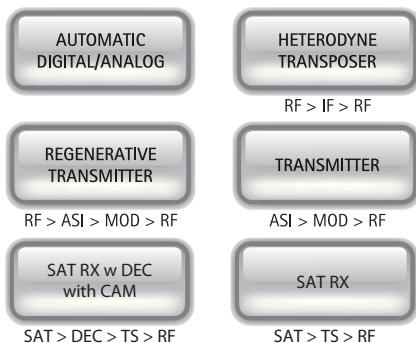

Main Features

- Transmission in VHF and UHF bands
- MFN and SFN operations
- Internal GPS receiver
- Embedded HTTP server
- RF main and monitoring outputs
- Linear and Non-Linear Adaptive digital pre-correction circuits, when operated as transmitter
- Linear and non-linear digital pre-correction circuits, when operated as repeater
- T2-MI input over IP or ASI
- Modulated DVB-T2 RF signal input (VHF/UHF) – when operating as repeater
- T2-MI input RF signal (VHF/UHF) – specific for SFN gap filler operation
- Signal modulation compliant with ETSI EN-302 755 (DVB-T2) standard 1.3.1
- ETSI EN 300 744 v16.1
- ETSI TS 101 191 v1.4.1
- ETSI EN-102 773 (T2-MI)
- ITU -R BT. 470-7
- Full support of T2 modulation up to 256-QAM including I/Q rotation
- T2-MI compliant with standard
- Full Single-PLP and MPLP compatibility (including MISO and PAPR reduction)
- Up to 16 PLP
- Bit rate adaptation plus PCR restamping in S-PLP

Option Features

Based on Software Defined Technology (SWDT), ARK6 T2 Modulator allows the definition of different operative modes on the same hardware platform.



SDT SERIES ARK-6 ISDB-T + ATV

The New SDT ARK-6 SERIES is available in different hardware configurations.



Front View. Transposer and Transmitter Version



Front View. Version with Analog Audio/Video Input



Front View. Transmitter with DVB-S2 Receiver Version



Front View. Transmitter with DVB-S2 Receiver Version with CAM



Front View. Transmitter Version

General Specifications	
Cooling System	Forced air/liquid cooling
Local control and monitoring	Extensive front panel control Local terminal on RS-232
Remote control and monitoring	Web based Java Interface Telnet access via Ethernet SNMP
Operating Temperature	-10°C to +45°C
Maximum relative humidity	90%, non condensing
Maximum operating altitude	2500 m a.s.l. (> 2500 m on request)
Mains power supply	90-260 VAC, 380 VAC (3 Phases) other available on request

MODEL SPECIFIC DATA

Models	Output Band	Working Class	Dimensions	N. Ampl	kind of Ampl	Output Connector	Cooling	Meter board N.	Shoulders @ Fo ± 4.3 MHz	Digital output power (rms) without Filter ISDB-T	Nominal analog output power (p.s.) ATV
SDT 403UM-W ARK-6 HE	UHF	AB	4 X 40 RU	16	SCA202HE-W	4+1/2"	Liquid	4	-39	20000 W	48000 W
SDT 403UM-W ARK-6	UHF	AB	4 X 40 RU	16	SCA202UB-W	4+1/2"	Liquid	4	-36	10000 W	40000 W
SDT 403TM-W ARK-6	VHF (III)	AB	4 X 40 RU	16	SCA202TB-W	4+1/2"	Liquid	4	-36	10000 W	40000 W

Specifications and characteristics are subject to change without notice.



GUI, modulation page.



GUI, main page.



GUI, input page.

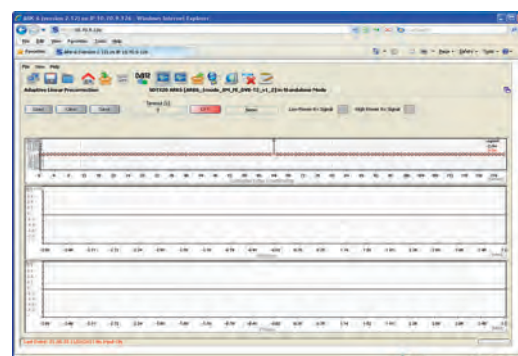

GUI, linear pre correction page.

Heterodyne Transposer, Regenerative Transmitter, Transmitter up to 72000W ps/30000W rms – Liquid Cooled Version



> SDT 603 ARK-6
With Dual Driver Option and Liquid Cooling

Description

The New SDT ARK-6 Series is the result of years of research and represents the state of the art of the worldwide transmitter technology.

We call it UNIVERSAL DRIVER because of its incredible capability to be all configurations with one hardware and uploading a proper software package.

It is perfect for both international broadcasters which have business in several countries – to increase manageability of investment through reduction of transmitter types – and national broadcasters, due for its versatility in operation modes and configuration. In fact it can be used as a transmitter, a heterodyne transposer, a regenerative transmitter, all in a single hardware. ARK-6 UNIVERSAL DRIVER is resilient to future evolutions of technology and standardization: this DRIVER guarantees a perfect upgrade path for new modulation schemes that the researchers will delivery.

Besides ARK-6 UNIVERSAL DRIVER already implements DVB-T/T2, ATSC/MH, ISDB-T, DTMB, ATV modulations.

The SDT ARK-6 allows selection of transmission modes in various ways: remotely, using a dry contact; via SNMP commands; via TCP/IP, using the Web graphic interface; or even via a dedicated command inserted into the transport stream.

Functional interfaces are available for total remote control of the apparatus by means of serial protocols or TCP/IP ports. Thanks to the internal Web server the apparatus can be easily monitored and configured and updated using a LAN connection and a standard Web browser. More over, the built-in SNMP agent allows full automated remote control.

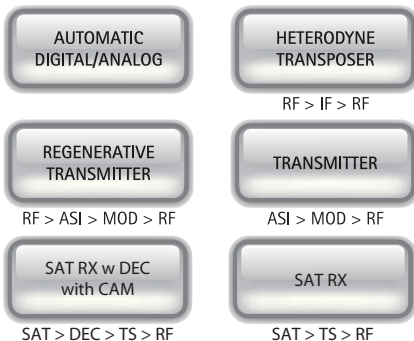

Main Features

- Transmission in VHF and UHF bands
- MFN and SFN operations
- Internal GPS receiver
- Embedded HTTP server
- RF main and monitoring outputs
- Linear and Non-Linear Adaptive digital pre-correction circuits, when operated as transmitter
- Linear and non-linear digital pre-correction circuits, when operated as repeater
- T2-MI input over IP or ASI
- Modulated DVB-T2 RF signal input (VHF/UHF) – when operating as repeater
- T2-MI input RF signal (VHF/UHF) – specific for SFN gap filler operation
- Signal modulation compliant with ETSI EN-302 755 (DVB-T2) standard 1.3.1
- ETSI EN 300 744 v16.1
- ETSI TS 101 191 v1.4.1
- ETSI EN-102 773 (T2-MI)
- ITU -R BT. 470-7
- Full support of T2 modulation up to 256-QAM including I/Q rotation
- T2-MI compliant with standard
- Full Single-PLP and MPLP compatibility (including MISO and PAPR reduction)
- Up to 16 PLP
- Bit rate adaptation plus PCR restamping in S-PLP

Option Features

Based on Software Defined Technology (SWDT), ARK6 T2 Modulator allows the definition of different operative modes on the same hardware platform.



SDT SERIES ARK-6 ISDB-T + ATV

The New SDT ARK-6 SERIES is available in different hardware configurations.



Front View. Transposer and Transmitter Version



Front View. Version with Analog Audio/Video Input



Front View. Transmitter with DVB-S2 Receiver Version



Front View. Transmitter with DVB-S2 Receiver Version with CAM



Front View. Transmitter Version

General Specifications	
Cooling System	Forced air/liquid cooling
Local control and monitoring	Extensive front panel control Local terminal on RS-232
Remote control and monitoring	Web based Java Interface Telnet access via Ethernet SNMP
Operating Temperature	-10°C to +45°C
Maximum relative humidity	90%, non condensing
Maximum operating altitude	2500 m a.s.l. (> 2500 m on request)
Mains power supply	90-260 VAC, 380 VAC (3 Phases) other available on request

MODEL SPECIFIC DATA

Models	Output Band	Working Class	Dimensions	N. Ampl	kind of Ampl	Output Connector	Cooling	Meter board N.	Shoulders @ Fo ± 4.3 MHz	Digital output power (rms) without Filter ISDB-T	Nominal analog output power (p.s.) ATV
SDT 603UM-W ARK-6 HE	UHF	AB	6 X 40 RU	24	SCA202HE-W	6+1/8"	Liquid	6	-39	30000 W	72000 W
SDT 603UM-W ARK-6	UHF	AB	6 X 40 RU	24	SCA202UB-W	6+1/8"	Liquid	6	-36	15000 W	64000 W
SDT 603TM-W ARK-6	VHF (III)	AB	6 X 40 RU	24	SCA202TB-W	6+1/8"	Liquid	6	-36	15000 W	64000 W

Specifications and characteristics are subject to change without notice.

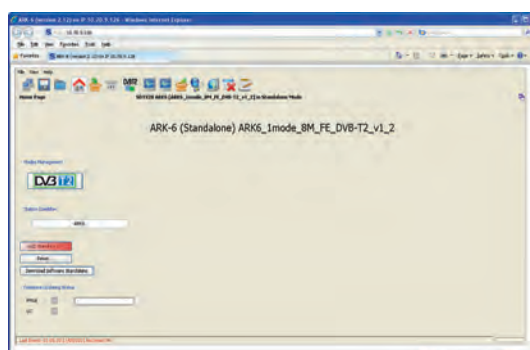

GUI, modulation page.

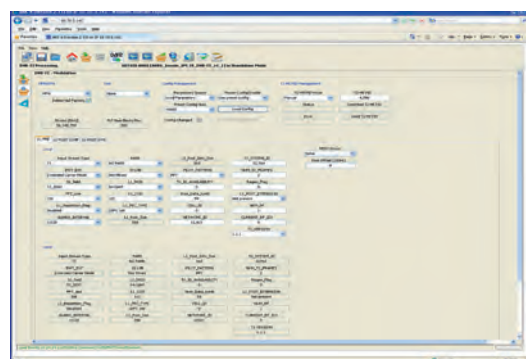

GUI, main page.



GUI, input page.

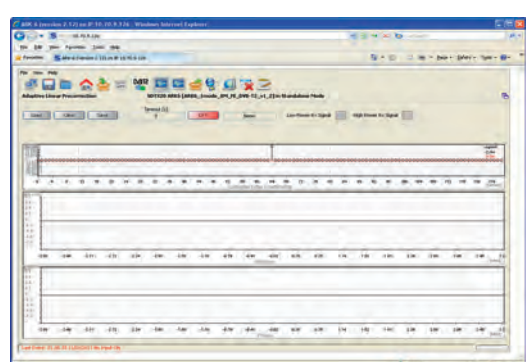

GUI, linear pre correction page.

Accessories and Synchronization Systems

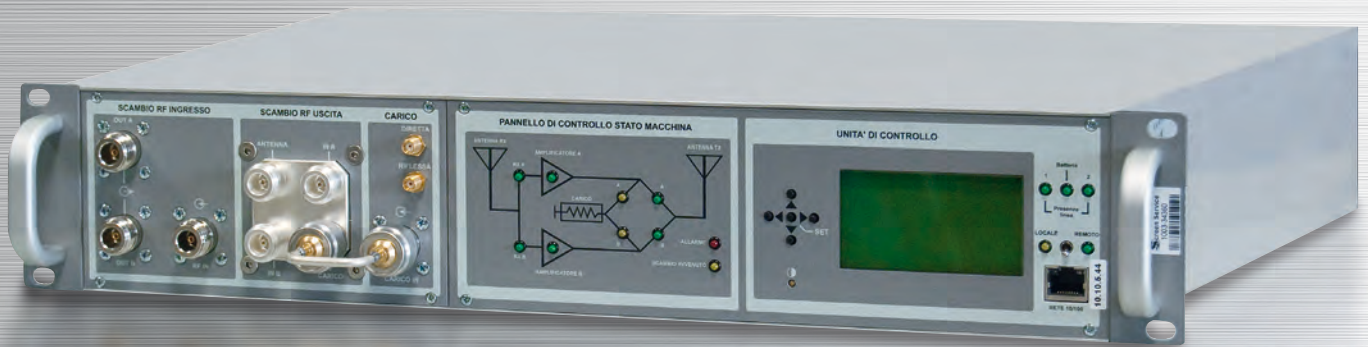

Accessories and Synchronization Systems

Automatic Changeover (1+1, N+1)

Single or Dual GPS Receiver

GPS Smart

ASI to IP Converter

ASI distributor



Main Meter



> SCS 300/350

Description

The SCS 300/350 (for dual driver system) Main Meter Unit is designed for complete managing platform for transmitters/ transposers.

- Local and Remote control of all system parameter via SNMP, Web, TLC/TLS
- Controller power out
- Local Transmitter and Transposer managing capabilities;
- Analog and Digital (multimode) management

Watt meter in order to control:

- Reflected power after filter
- Forward power after filter
- Reflected power before filter
- Forward power before filter

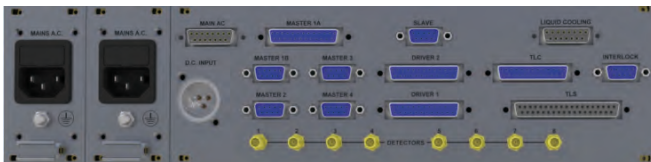

Rear view Main Meter SCS300



Automatic Changeover Unit (1+1)



> SCS 500

Description

The SCS 500 performs the switching between two transmitters or transposers in a 1+1 Driver configuration and in a 1+1 with reserve configuration.

SCS 500 change-over detects the presence of the IF or RF signal and in case of absence of the primary signal to switch on the spare one and vice-versa.

The SCS 500 used in transmitter applications switches the Audio/Video signals and IF/RF from one driver to the other one. Some of them, as indicated in the previous table, use an internal coaxial bi-stable and motorized relays (SPINNER or RADIALL) depending on the output power. Some others drive an external high power coaxial, bi-stable and motorized Relays.

The SCS 500 used in transposer applications switches the RF signal from one driver to the other one. Also in this case, some of them, as indicated in the previous table, use an internal coaxial bi-stable and motorized relays (SPINNER or RADIALL) depending on the output power. Some others drive an external high power coaxial, bi-stable and motorized Relays.

The SCS 500 front panel of the transmitter application have two audio inputs: 1 main and 1 spare; four video inputs (video + SDI or ASI): main and spare; one audio output; two video outputs (video + SDI or ASI). Few configurations have a graphic panel (with led) that show the relays status.

The SCS 500 front panel of the transposer application have two RF (N connector) output to the drivers and one input for the signal coming from the antenna. Few configurations have a graphic panel (with led) that show the relays status.

If SCS 500 unit is used with Screen Service Series transmitters and transposers a direct interconnection is made by means of DB25 connectors on the back panels of the equipment. This connection carries alarm and control signals and allows "safety" function to switch-down the transmitters during the switching. If the unit is used with equipment of different brands it is possible to switch-down the driver or the modulator using the two SMA connector located on the rear panel.

The SCS 500 is designed with a modular approach in a 19" , 2U standard RACK and the modularity refers to the plug-in units equipped with coaxial relays both for TRANSPOSERS and TRANSMITTERS.

The SCS 500 is equipped with two power supplies and a battery. So it can manages the alarms (via SNMP) also in case of failures.

Main Features

The SCS 500 Change Over Unit is designed especially for TV Broadcasting Transmitters, Transposers and Repeaters, operating in 1+1 arrangements. Based on a modular concept, the SCS 500 is capable to handle multi standard both in Digital and Analog. The equipment is based on high performance relays architecture to have a spare function to prevent a total system collapse. This security risk management function will help to eliminate single point failure conditions, thus preventing possible disastrous events granting an higher system MTBF.

- Double power supply;
- Single pole, double trough (double depending on configuration);
- Double pole, double trough;
- Transmitter and Transposer managing capabilities;
- Local and Remote Full Control;
- Analog and Digital management

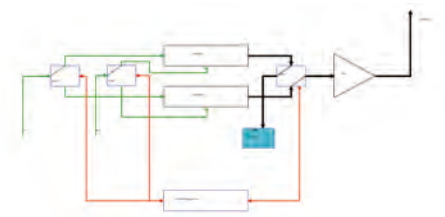

Internal Relay Configuration Management

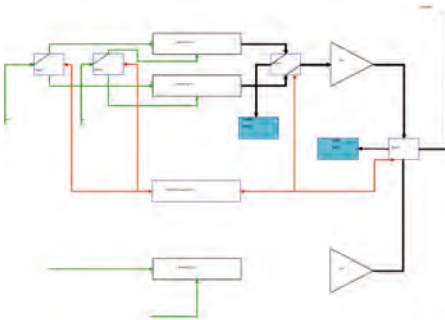

Internal + external Relay Configuration Management

Models and Options

SCS 500

Automatic changeover for transmitter applications with an integrated 1 ways relays. (on request A/V, ASI switching)

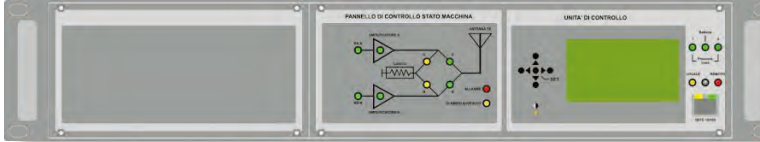

SCS 500M

Automatic changeover for transmitter applications with an integrated 2 ways relays, dummy load and fan.



SCS 500RO (X)

Automatic changeover with graphic panel for transmitter applications suitable only for external relays use. Support all kind relays (input solenoid drive, motor drive) Interlock.

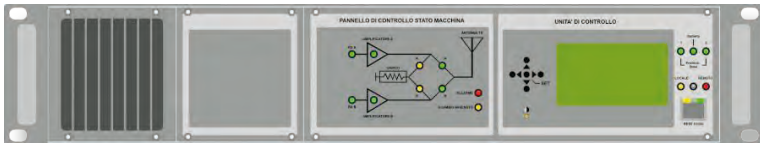

SCS 500RF

Automatic changeover with graphic panel for transposer applications with an integrated 2 ways relays . Like M model with Input/ Output RF Front side

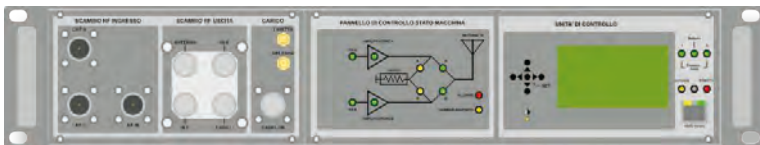

SCS 510MS (500MS)

Automatic changeover with graphic panel for transmitter applications with an integrated 2 ways relays, dummy load and fan and input RF splitter.

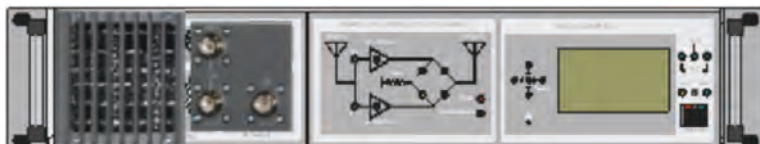

SCS 500MR

Automatic changeover with graphic panel for transmitter applications with an integrated 2 ways relays, dummy load and fan.

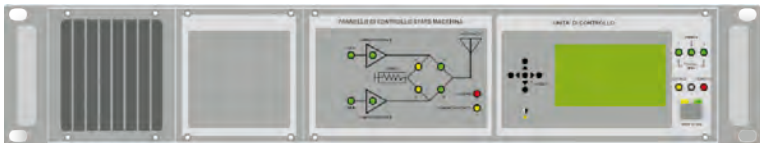

SCS 500NM: Automatic changeover for transmitter applications suitable only for external relays use. Support all kind relays (input solenoid drive, motor drive) Interlock.



SCS 50012VB: Automatic changeover for transmitter applications with an integrated 1 ways relays. Power supply 12V



TECHNICAL SPECIFICATIONS	
System Capability	1+1 MAIN & RESERVE
Control Remote	USB front panel
	RS 232 rear panel
	RS 485 rear panel
	GbE front panel
	Parallel rear panel
Control local	Push button front panel
Management	Automatic / Manual
Visualization Status Remote	Applet java
Visualization Status Local	Display / led
Main Supply	AC, double 90 to 264 VAC - DC, single 24 VDC
Power Consumption	< 10 W
Dimension	19", 2U RACK STANDARD, 450 mm D
Weight	5 Kg
Handling RF Power TX	65 W RMS (higher with external relays)
Handling RF Power RX	1 W RMS
Connector TX OUT	N FEMALE
Connector RX IN	N FEMALE (RT version)
Connector ASI IN	BNC FEMALE (TX version)
Impedance	50 Ohm (RF) - 75 Ohm (ASI) - 75 Ohm (Analog Video)
Return Loss	<1.2 :1

Automatic Changeover Unit (N+1)



> SCS 900



REAR VIEW GUESTS COAXIAL RELAYS AND DB25 PORTS

Model and Options

SCS 900: Automatic changeover unit stand alone unit (N+1).

SCS 900X: Automatic changeover for transmitter applications with an external relays use.

SCS 900TA: Automatic changeover for transmitter applications with an integrated 2 ways relays.

SCS 900TA4: Automatic changeover for transmitter applications with an integrated 4 ways relays.

Description

The SCS 900 model is an automatic change-over unit that controls and operates television transmitters and transposers, both analogue and digital, as well as microwave links, with configurations ranging from 1+1 to 8+1.

All dialogues with controlled units take place through an ultimate generation micro-processor.

The System management has been made extremely simple thanks to multiple local or remote interfaces (RS-232, RS-485, parallel contacts, SNMP, USB and LAN).

The user may select either the manual or automatic mode and on/off or switching functions may be activated remotely.

Main Features

- From 1 to 8 programs/channels + one back-up.
- Local/remote control.
- Automatic/manual mode.
- USB, RS-232, RS-485, LAN, SNMP management interface, parallel contacts.
- Management of switching delay.
- Memorization of events and alarms.
- Incorporated Real Time Clock.
- Priority management.
- Threshold levels and number of retries may be adjusted by user.
- Operative frequency: DC to 1 GHz.
- Compact size: 3 RU (19").

TECHNICAL SPECIFICATIONS

TECHNICAL SPECIFICATIONS	
INPUTS	
Operating frequency range	DC to 1 GHz
Input impedance	50 Ω
Insertion loss	< 0.8 dB
Return loss	< -20 dB
Isolation between channels	> 80 dB
Switch type	D.P. - D.T. microstrip
Input connector	N, female
OUTPUTS	
Operating frequency range	DC to 1 GHz
Max operating power	Up to 200 W p.s. with internal relays
Output impedance	50 Ω
Insertion loss	< 0.2 dB
Return loss	< -26 dB
Switch type	D.P. - D.T. coaxial
Isolation between channels	> 80 dB
Input connector	N, female (other on request)
GENERAL	
Number of programs and/or channels	Up to 8 (Main) + 1 (reserve)
Control	Local and remote
Operations	Automatic or manual
Management interfaces	RE 232, RS 485, LAN, USB, opto-isolated parallel contacts, local push-buttons
Monitoring Interfaces	Web based Java Interface Front panel display
Operating temperature	-10°C to +45°C
Maximum relative humidity	90%, non condensing
Main supply	90 to 264 V AC / 24 V DC
Power consumption	< 10 W
Dimensions	3 or 6 RU (19" rack)
Weight	< 5 kg



SCS120S : GPS Receiver, 10 Output x 1PPS, 10 or 5MHz Outputs stand-alone unit.

SCS120D : Dual Redundant GPS Receiver, 10 Output x 1PPS , 10 or 5MHz Outputs stand alone unit Seamless



SCS 120D



SCS 120S

Description

The systems in these series represent the ideal solution to problems of synchronization for distribution networks of broadcasting signals or in every kind of network that required Frequency and Timing reference. They make possible to obtain a high-precision frequency source wherever there is unavailable GPS signal. The GPS receivers, designed with "Carrier Aided Tracking" technology with 12 parallel channels, are available in single or redundant version with automatic seamless switch-over , which provides a commutation without interruption.

Distributors are available, moreover, for frequency reference signals as well as for timing-reference signals. The discontinuity of the presence of the reference signal does not jeopardize operation of the equipment, thanks to the substantial stability of the oscillator.

The sturdiness of the system in case of reference signal lack was obtained by comparing the local source frequency with the reference signal frequency and correcting the possible drift of the local frequency of the integrated oscillator

The dual GPS Receiver contains two fully redundant GPS receiver boards, each with their own OCXO, GPS module and GPS antenna input. The redundancy is at power supply level as well. Each receiver has an OCXO (oven controlled crystal oscillator) which runs at 10MHz. The accuracy of this OCXO is better than $\pm 0.3\text{Hz}$ (0.3 ppm). When the GPS signal is present and is detected, the OCXO frequency is controlled to match the accuracy of the GPS time reference. The number of cycles of this signal is counted over a period of one second, as given by the 1PPS signal from the GPS module. This way the frequency error of the OCXO is derived. If the GPS module tracks only 3 satellites or less, it becomes impossible to extract the GPS time information. If this happens, the microcontroller stops adjusting the OCXO frequency. The OCXO is left running in open loop, with the last tuning voltage known before the GPS module lost track. When both receivers do not receive the GPS signal, then the frequency accuracy is set by the OCXO accuracy, which is less than 0.3ppm. this function is named Hold Over

GPS RECEIVER

- 12 parallel channels.
- C/A code 1,023 MHz chip rate.
- Carrier Aided Tracking.
- Precision in position: 25 m (SA absent), 100 m (SA spec. UD DoD)
- Suitable for use with active antennas.
- LAN TCP/IP
- Aux TLS relay contact available on the rear panel.
- RS485,RS232 Communication



GPS receiver rear view
(version with GPS Input on the front-panel)



GPS receiver rear view



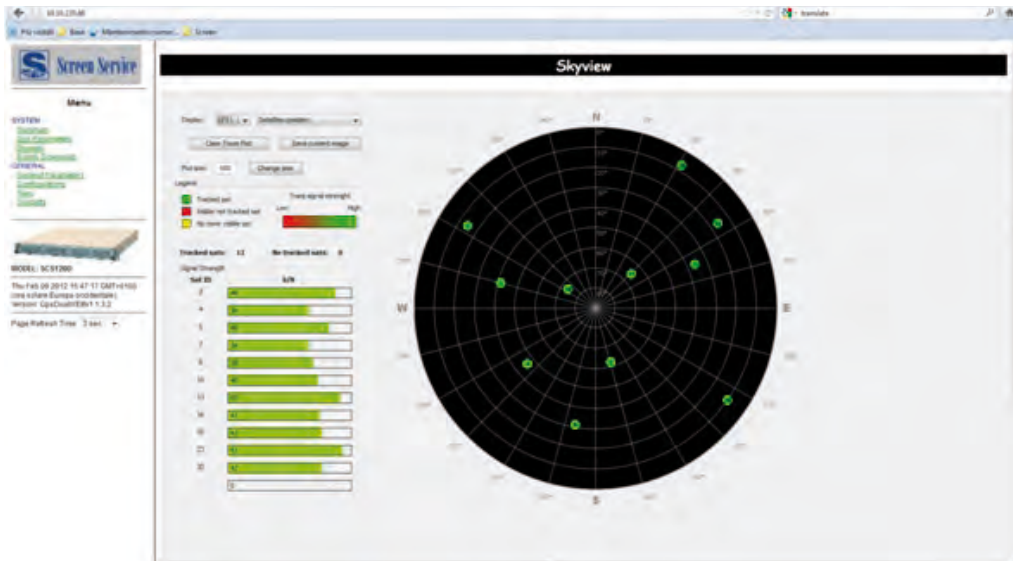

*Skyview

The Gps2 Parameters control panel is divided into two main sections: Alarms & Traps and Measures. The Alarms & Traps section contains a table of configuration options for various alarms. The Measures section contains a table of current system parameters.

Alarms & Traps		
	Alarms	Traps
Locked Alarm	On	Disable
SD Fix Alarm	On	Disable
Disciplining Warning	On	Disable
Serial Link Alarm	On	Disable
PPS Alarm	On	Disable
DOXO Alarm	On	Disable
Holover Alarm	On	Disable
Holover Ready	On	Disable

Measures		
Locked		Locked
Holover Ready		On
Date		13/02/2012
UTC Time		14:18:59
Latitude		45°29'59"
Longitude		10°09'30"
Height [m]		16475
Precision [m]		3
Precision Level		1
Holover Counter		24 h 0 min
Timing Function		Enabled
DNC		32877

*Control Panel

FREQUENCY REFERENCE

Number of outputs	10 x BNC, 50 Ω
Output signal	5 or 10 MHz, sine wave, 1 V p.p
Short term stability	Better than 5×10^{-12} (1sec)
Frequency accuracy	Better than 3×10^{-12} (24hours continuous power up and GPS)
Hold over drift	$\pm 5 \times 10^{-10}$ /day
Phase noise @ 100 Hz	Better than -145 dBc/Hz
Phase noise @ 10 kHz	Better than -155 dBc/Hz
Cold startup	Less than 10 min.

TIMING REFERENCE

Number of outputs	10 x BNC, 50 Ω
Output signal	1 PPS, 5 V TTL, square wave
Timing accuracy	± 100 ns peak (24 hours continuous power up and GPS)
Holdover drift	± 1 μ s (3 hours without GPS) < 8 μ s (24 hours without GPS)

GENERAL

GPS antenna input connector	N female, 50 Ω , lightning protection available as option
Switchover function (redundant models only)	Auto
Operating temperature	-10°C to +45°C
Maximum relative humidity	90%, non condensing
Power supply	90 to 264 V AC, 24/48 V DC
Dimensions	1 RU (19" rack)
Weight	5 kg (approx)

OPTIONS

Power supply in redundant configuration
Lightning protection
5 MHz output (2MHz on request)
Rear Input GPS antenna
Kit SCS 118/Mobil Antenna GPS



GPS Receiver, 4 x 1PPS / 4 x 10MHz Outputs – stand-alone unit.



GPS Smart



GPS receiver front view



GPS receiver rear view

Description

GPS SMART with a compact and light modular hardware design to bring you a powerful time & frequency reference system at the lowest cost. Intelligent solution for all your requirements for time synchronization and frequency. The GPS receivers, designed with "Carrier Aided Tracking" technology with 50 parallel channels. Distributors are available, moreover, for frequency reference signals as well as for timing-reference signals. The discontinuity of the presence of the reference signal does not jeopardize operation of the equipment, thanks to the substantial stability of the oscillator.

Main Features

GPS RECEIVER

- 50 parallel channels.
- C/A code 1,023 MHz chip rate.
- Carrier Aided Tracking.
- Precision in position: 25 m (SA absent), 100 m (SA spec. UD DoD)
- Suitable for use with active antennas.
- LAN TCP/IP
- Aux TLS relay contact available on the rear panel.

FREQUENCY REFERENCE

Number of outputs	4 x BNC, 50 Ω (2 rear and 2 front side)
Output signal	10 MHz, sinewave, 1 V p.p.
Short term stability	Better than 5x10 ⁻¹² (1 sec.)
Frequency accuracy	Better than 3x10 ⁻¹² (24 hours continuous power up and GPS)
Holdover drift	±5x10 ⁻¹⁰ /day
Phase noise @ 100 Hz	Better then -145 dBc/Hz
Phase noise @ 10 kHz	Better then -155 dBc/Hz
Cold startup	Less then 10 min.

TIMING REFERENCE

Number of outputs	4 x BNC, 50 Ω (2 rear and 2 front side)
Output signal	1 PPS, 5 V TTL, square wave
Timing accuracy	±100 ns peak (24 hours continuous power up and GPS)
Holdover drift	±1 μs (5 hours without GPS) < 24 μs (24 hours without GPS)

GENERAL

GPS antenna input connector	N female, 50 Ω (rear or front side), lightning protection available as option
Operating temperature	-10°C to +45°C
Maximum relative humidity	90%, non condensing
Power supply	100 to 240 V AC, 50 to 60Hz or 24 V DC
Dimensions	1 RU (19" rack) half unit 484 mm (W) x 350 mm (D) x 45 mm (H)
Weight	2 kg (approx.)

OPTIONS

Lightning protection	
5 MHz output (2MHz on request)	
Kit SCS 118/Mobil Antenna GPS	



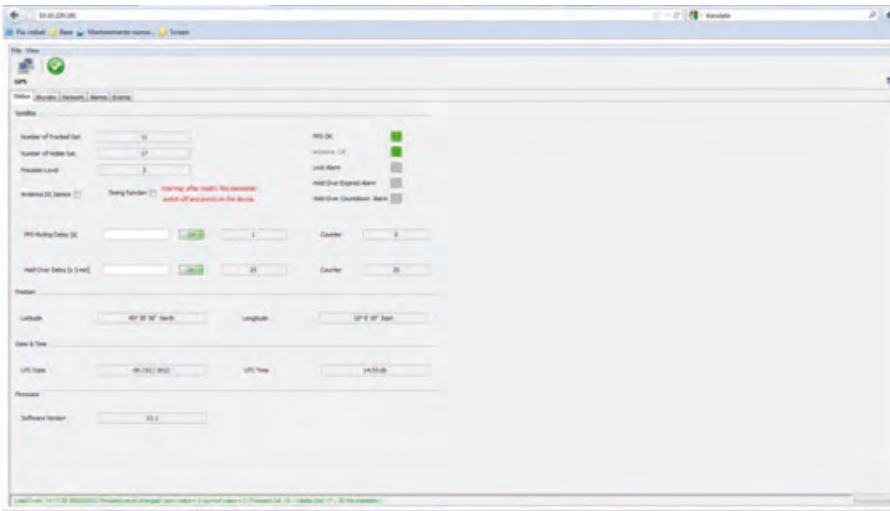

*Control Panel

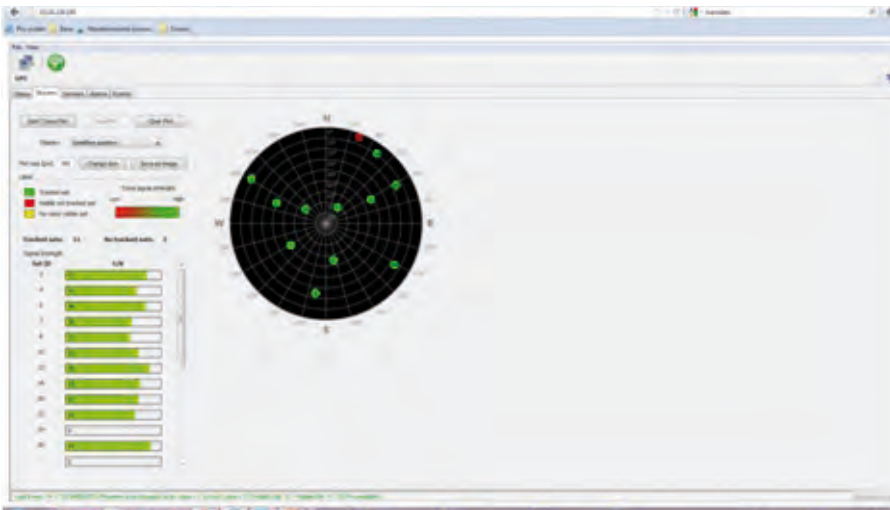

*Skyview

8 channels ASI to IP and IP to ASI Converter



> Redundant ASI - IP



> Portable Version ASI - IP

Description

SMPT E Specification 2022-1: Forward Error Correction for Real-time Video/Audio Transport Over IP Networks
Modern data networks are subject to a variety of impairments, ranging from simple bit errors to groups of contiguous data packets.

The Pro-MPEG COP3/SMPT E 2022 standard has been designed specifically to ensure that high quality video that is used by broadcasters for their most valuable live video feeds are able to be transported over these networks.

COP #3 FEC can protect a video stream from a burst packet loss of up to 255 packets, which is suitable for most private, managed IP networks using QoS techniques such as MPLS, RSVP, and DiffServ. COP #3 FEC is available as the option within user datagram protocol (UDP)/IP network encapsulation, with real-time transport protocol (RTP) encapsulation.

The generation of FEC packets in the COP #3 standards is based upon a matrix defined by the parameters L and D. L represents the number of columns in the matrix, while D represents the number of rows. The standard defines the generation of two types of FEC packet: Column FEC and Row FEC. A FEC packet is generated by XOR of the media packets in a column or a row. Once generated, the Column FEC packets and Row FEC packets are transmitted along with the original media packets on 3 separate UDP ports to a Pro-MPEG COP #3 compliant receiving device.

SMPT E-2022 Network Adapters provide a cost effective and highly reliable solution for transporting digital video content over IP networks (MPEG2-TS over IP also called DVB over IP or ASI over IP)

While Pro-MPEG COP #3 FEC is adequate for most private IP links, it is not robust enough to handle the challenges associated with moving video over highly loss IP networks such as the Public Internet.

Main Features

- It is a portable translator that provides seamless conversion between different MPEG2-TS transmission media.
- ASI->Ethernet, Ethernet->ASI converter, designed for the distribution of MPEG2-TS.
- It is capable to route TS from ASI to Ethernet and for Ethernet to ASI, managing Forward Error Correction data channel as requested by SMPT E 2022 standard.
- Full SMPT E 2022 (Pro MPEG-COP#3) standard compliant.

It provides three working modes:

- 1) ASI to Ethernet mode: provides the routing of up to 2 ASI input to 2 Ethernet outputs.
- 2) Ethernet to ASI mode: provides the routing of up to 2 Ethernet input channels to 2 ASI outputs.
- 3) 2 Way Bridge mode: working mode allows to use both function, ASI to GbE and GbE to ASI simultaneously, this working mode use the ASI1 and the GbE2 as input and the GbE1 and the ASI2 as output.

- Fully programmable FEC with several selectable FEC mode:
 - Enable
 - Disable
 - One-dimensional
 - Two-dimensional
- Selectable input buffer size (selectable latency)
- Resynchronization Output Bitrate PCR based
- Device settings and upgrade are managed by the included Graphic User Interface through a USB port.



Block diagram ASI to IP converter 2 ways

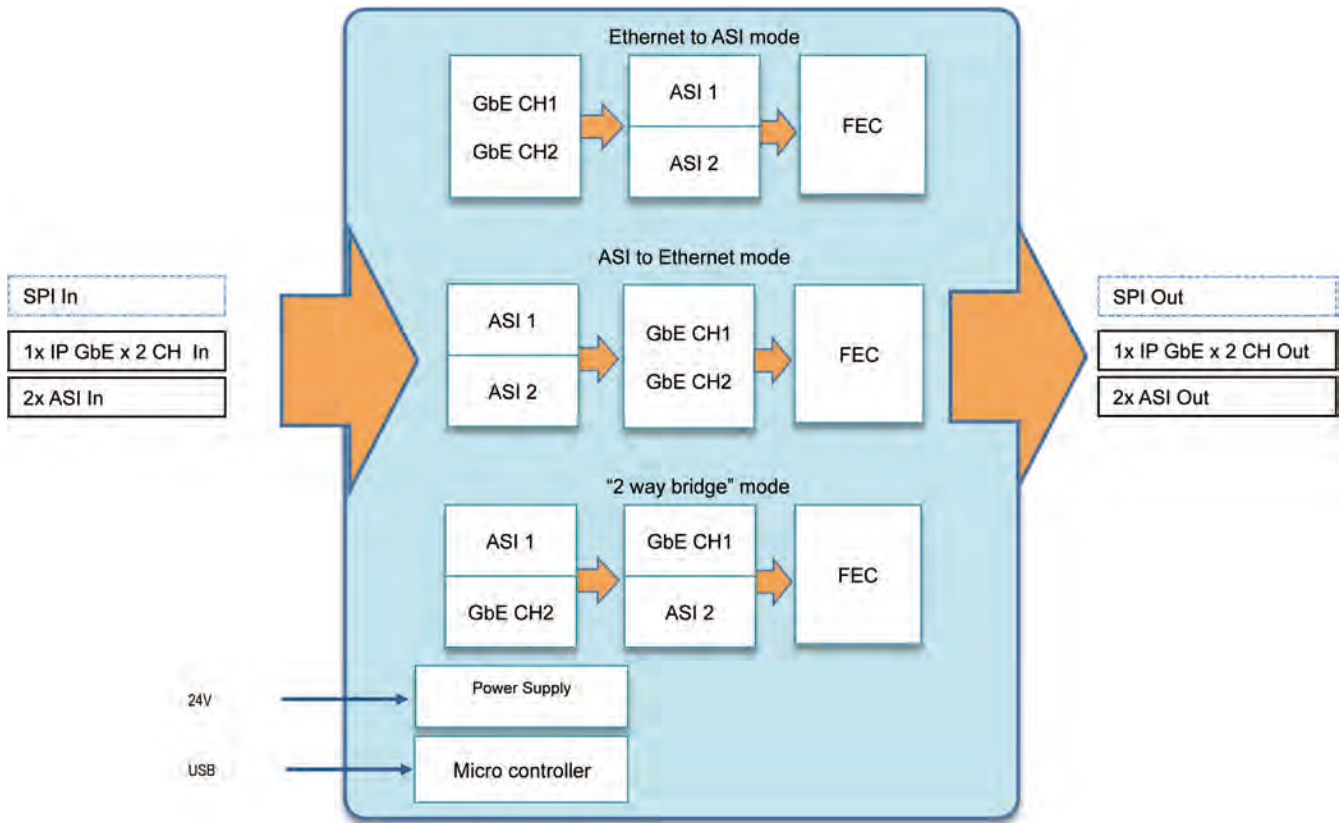

Block diagram ASI to IP converter 8 ways

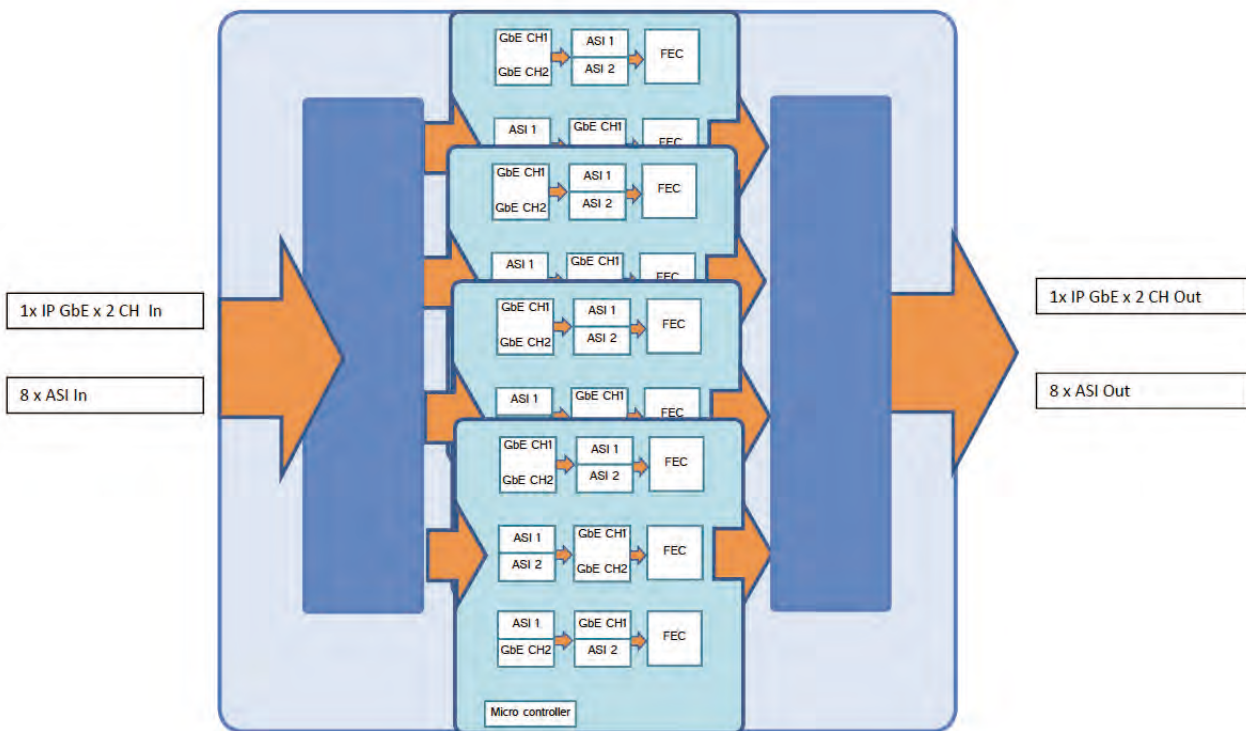

ASI to IP Gateway 0.1

Menu

- Ch 1: ASI to IP
- Ch 2: IP to ASI
- Ch 3: ASI to IP
- Ch 4: ASI to IP
- Ch 5: ASI to IP
- Ch 6: ASI to IP
- Ch 7: ASI to IP
- Ch 8: ASI to IP
- Setup
- Alarm
- Event

ScreenService
IT WORKS.

Board Name

Installer ASI2IP_gateway_0_0_2
Thu Mar 21 16:33:38 2013
IP address 10.70.5.120

Channel 1
ASI to IP

Channel 2
IP to ASI

Channel 3
ASI to IP

Channel 4
ASI to IP

Channel 5
ASI to IP

Channel 6
ASI to IP

Channel 7
ASI to IP

Channel 8
ASI to IP

Updating

FPGA

uC

Current alarms:

Alarm Channel 3 Alarm

Alarm Channel 4 Alarm

Alarm Channel 5 Alarm

Alarm Channel 6 Alarm

Alarm Channel 7 Alarm

ASI to IP Gateway 0.1

Menu

- Ch 1: ASI to IP
- Ch 2: IP to ASI
- Ch 3: ASI to IP
- Ch 4: ASI to IP
- Ch 5: ASI to IP
- Ch 6: ASI to IP
- Ch 7: ASI to IP
- Ch 8: ASI to IP
- Setup
- Alarm
- Event

Setup

SNMP

Trap IP 1

Trap IP 2

Trap IP 3

Get

Set

Common

IP Management Settings

IP address

Gateway

Netmask

MAC

Setting Date and Time

Date

Time

UTC Time offset

IP Data Settings

IP addr ch1-ch2

IP addr ch3-ch4

IP addr ch5-ch6

IP addr ch7-ch8

Gateway

Netmask

SYSLOG

IP Address

NTP Setting

IP Server Address



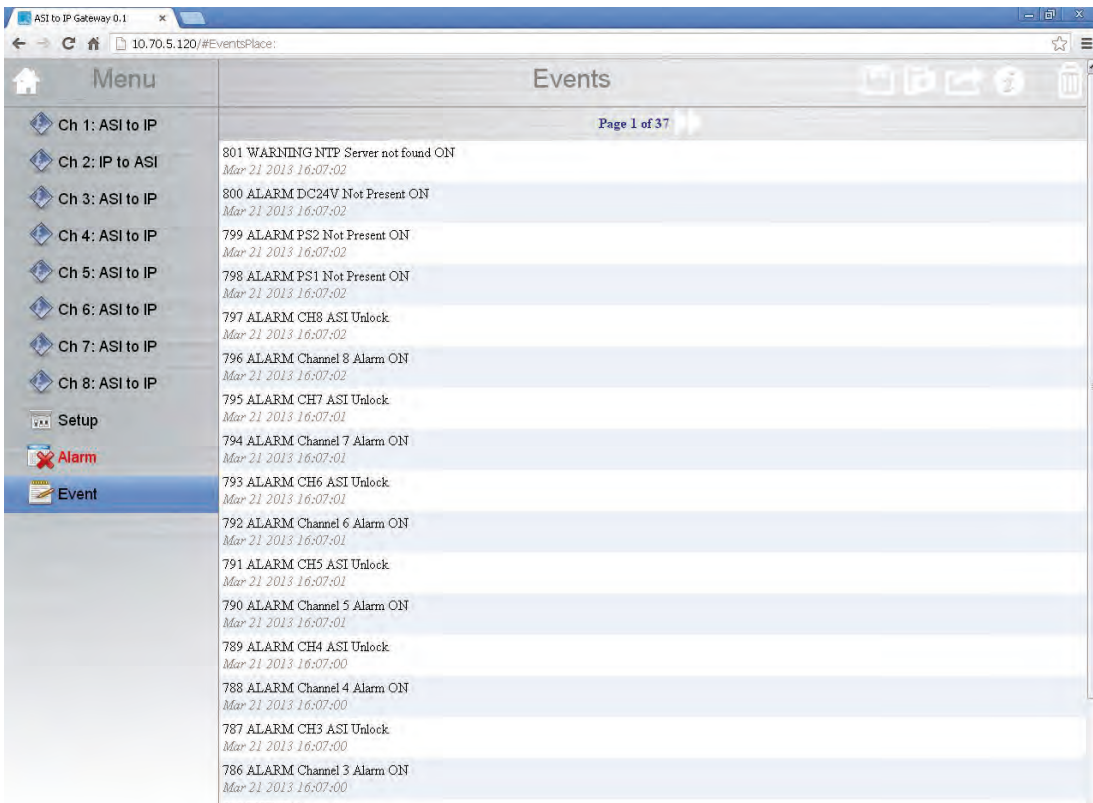
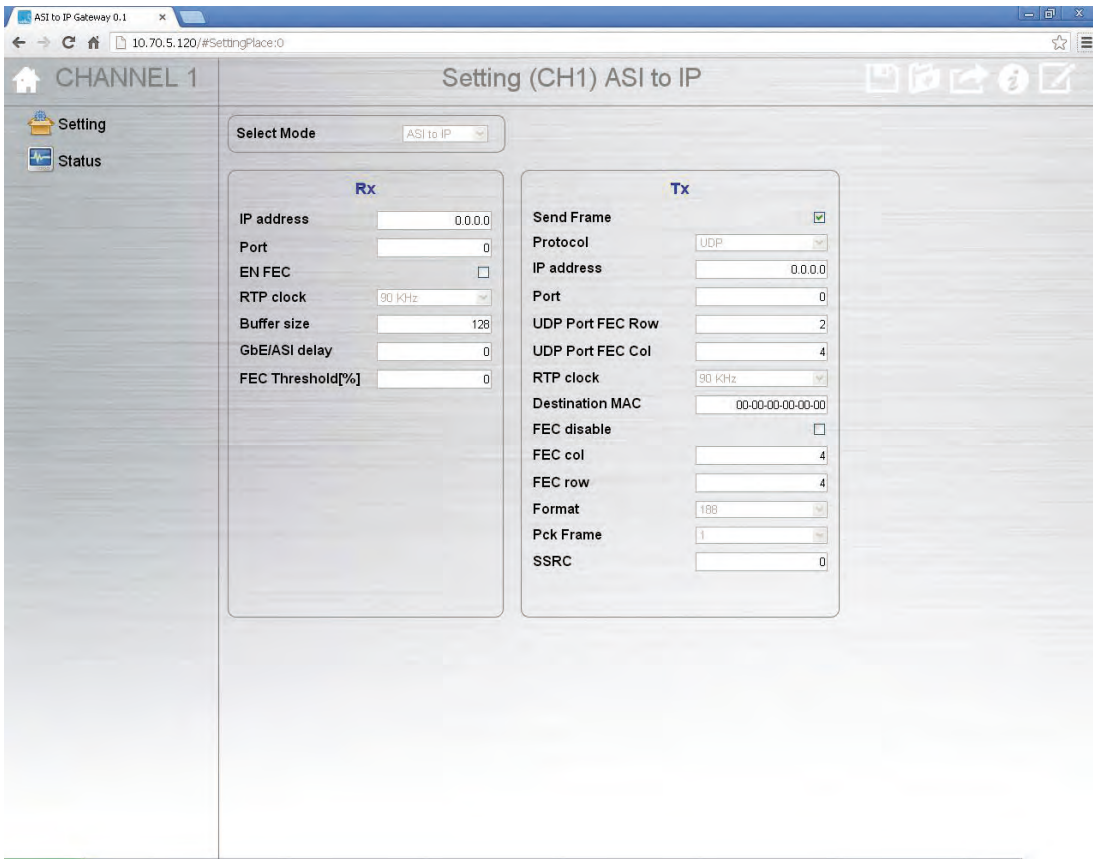

Redundant Asi Distributor



XBT 706D

Description

The XBT 706D enables a very flexible and easily manageable distribution of 1+1 Input to 6 + 6 Output SDI/DVB-ASI (270 Mb/s) for different purposes (microwave links back to back propagation, distribution of signal to monitoring and test equipment, general connectivity in the head end, etc.) together with the related clock. The system can be used either in multiple distribution option for up to 12 outputs or as a fully redundant unit for the 1 input to 6 outputs configuration of the XBT 600. To compensate for the signal distortion potentially introduced by long transmission (up to 200 mt.) an automatic line equalizer is present on the ASI input port. Besides that the outgoing signal is muted in case of lacking of the related incoming signal. The equipment has the possibility to mount the redundant power supply as standard base configuration.

Available on request the model XBT 706E with 4 SDI/DVB-ASI (270 Mb/s) input and 6+6+6+6 SDI/DVB-ASI (270 Mb/s) output with double power supply.



Rear View

Main Features Model XBT706D

INPUT

- 2 SDI/DVB-ASI (270 Mb/s) Inputs BNC connector, 75 ohm (also available in 1+1 fully redundant configuration)
- ASI fully comply EN 50083-9
- ASI bit rate 270Mbps
- Return loss >17dB
- Automatic equalization
- Auto re-clocker

OUTPUT

- 6 + 6 SDI/DVB-ASI (270 Mb/s) Outputs BNC connector, 75 ohm
- ASI fully comply EN 50083-9
- ASI bit rates 270Mbps
- 1 RU (19" rack)

Main Features Model XBT706E

INPUT

- 4 SDI/DVB-ASI (270 Mb/s) Inputs BNC connector, 75 ohm (also available in 1+1 fully redundant configuration)
- ASI fully comply EN 50083-9
- ASI bit rate 270Mbps
- Return loss >17dB
- Automatic equalization
- Auto re-clocker

OUTPUT

- 6 + 6 + 6 + 6 SDI/DVB-ASI (270 Mb/s) Outputs BNC connector, 75 ohm
- ASI fully comply EN 50083-9
- ASI bit rates 270Mbps
- 1 RU (19" rack)

Options

- Double and redundant power supply



GPS Antenna



> SCS 118 MOBI

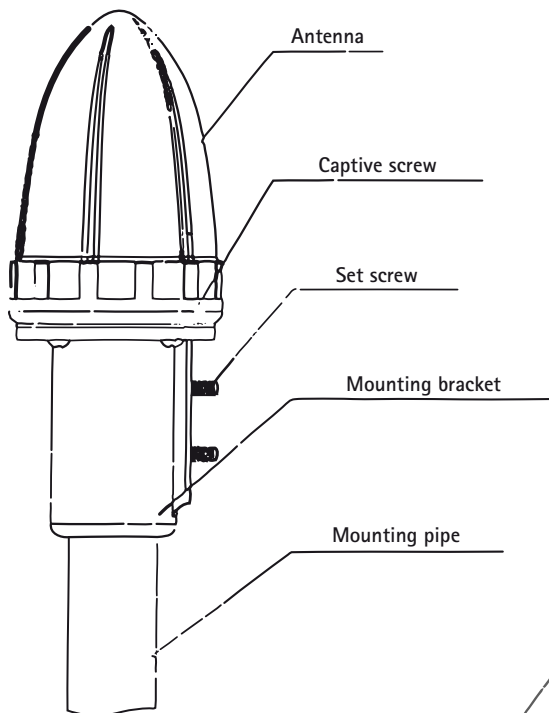

ELECTRICAL SPECIFICATIONS

Frequency Range(MHz)	1575.42±10
Polarization	Right hand circula
DC Voltage (V)	4.5 ~ 5.5
DC Current (mA)	≤ 60
Connector	(F) N (F)
Typical Gain of Ceramic Antenna	Better then -145 dBc/Hz
VSWR	Better then -155 dBc/Hz
Input Impedance (Ω)	Less then 10 min.
Amplifier Gain (dB)	26±3
Amplifier Input IP3 (dBm)	≥ -10
Amplifier Noise Figure (dB)	≤ 2.5 (at 26° C) ≤ 3.5 (entire frequency range)
Amplifier Filtering	Typical 3dB bandwidth 20 MHz ≥ 55dB (1575±50 MHz)

MECHANICAL SPECIFICATIONS

Radome material	ASA
Size (mm)	81 x 142.5 (including the connector)
Weight (Kg)	0,28
Operating Temperature (°C)	-40 ~ +75
Reposition Temperature (°C)	-55 ~ +75
Operating Humidity (%)	95
Operating Wind Speed (Km/h)	135
Rated Wind Speed (Km/h)	200
Circumstance	Outdoor

Packing List

- 1 x SCS 118 MOBI GPS Antenna
- 1 x User guide
- 1 x Mounting bracket assembly
- 1 x Allen wrench

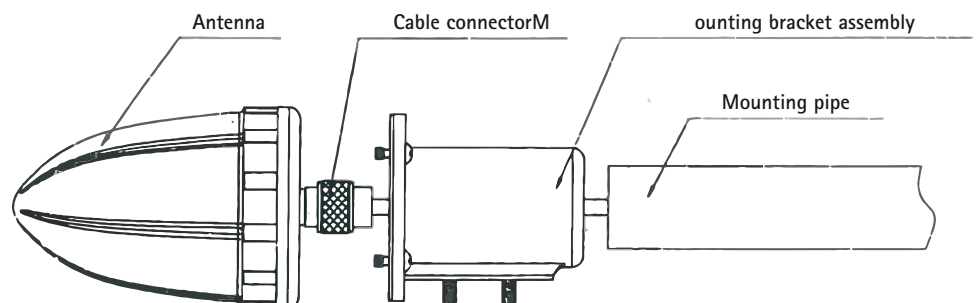

Test Measurement & Monitoring



Test Measurement & Monitoring

Multi Viewer

Power Meter Probe

SFN Analyzer

GPS Tester

XBT 52 ASI Killer

TS Compare

SSBT Broadcast Analyzer



Multiviewer Monitoring System



Front View

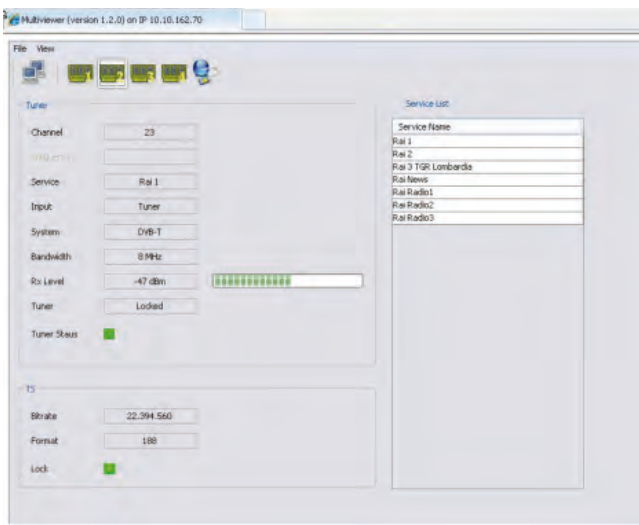

Java Control

Description

The new MWT family is a professional, attractively priced and compact solution for monitoring digital TV networks. It includes the DVB-T/T2 and the DVB-S/S2 receivers. Typical fields of applications for the MWT family are signal monitoring at the transmitter site, the satellite uplink or the head end. Simultaneous monitoring of signals T/T2 (option S/S2) with possibility to show 4 programs in the same time on display. 4 mini display HD Extensive RF measurements for DVB-T/T2 and DVB-S/S2 signals Available with CAM for encryption monitoring Modular and extremely compact design (3 RU)

Main Features

- LED backlight provides longer life, uses less power and provides better color saturation
- Space saving design - occupies only 3 RU
- Front controls for power, contrast, tint, color, brightness and NTSC/PAL selection
- Composite video loop through capability for all 4 monitors (always active regardless of power). Loop out termination is provided by auto termination switch in the BNC connector
- Self-powered 3 color tally system
- Low power consumption
- Case made of durable aluminum & steel
- Active matrix technology allows wide viewing angle
- Active matrix technology eliminates distortion
- Single A/C adaptor power supply provides power for all 4 monitors (included)
- Response Time: 10ms/10ms (Rising/Falling)



Multiviewer Monitoring System



Front View

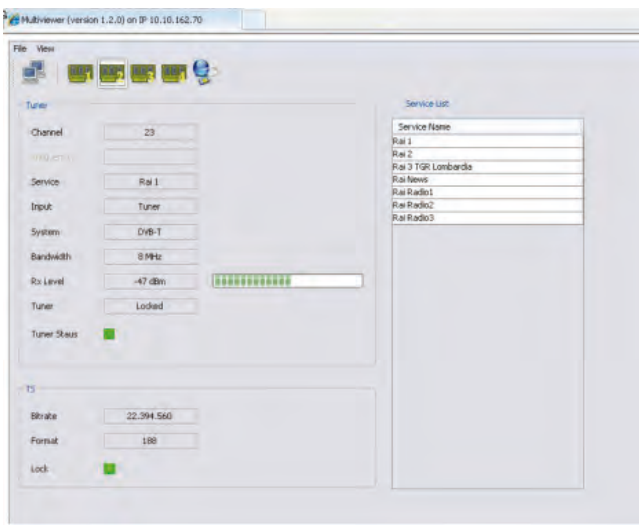

Java Control

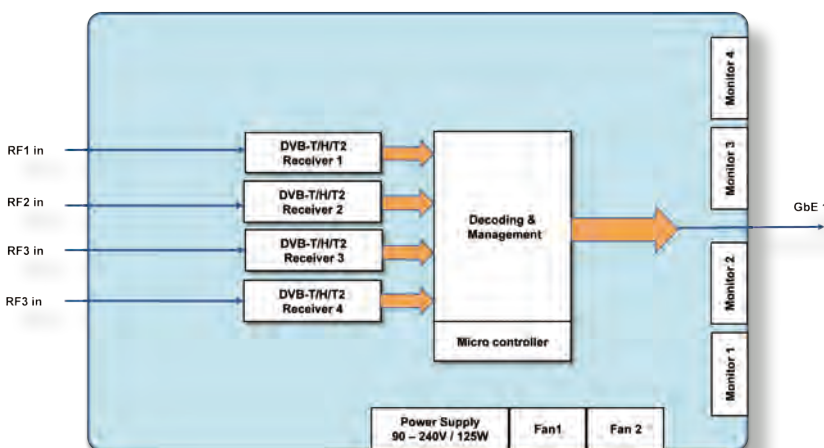

Block Diagram

Description

The new MWT family is a professional, attractively priced and compact solution for monitoring digital TV networks. It includes the DVB-T/T2 and the DVB-S/S2 receivers. Typical fields of applications for the MWT family are signal monitoring at the transmitter site, the satellite uplink or the head end. Simultaneous monitoring of up to four signals T/T2 (option S/S2) with possibility to show 4 programs in the same time on display. 4 mini display HD Extensive RF measurements for DVB-T/T2 and DVB-S/S2 signals Available with CAM for encryption monitoring Modular and extremely compact design (3 RU)

Main Features

- LED backlight provides longer life, uses less power and provides better color saturation
- Space saving design - occupies only 3 RU
- Front controls for power, contrast, tint, color, brightness and NTSC/PAL selection
- Composite video loop through capability for all 4 monitors (always active regardless of power). Loop out termination is provided by auto termination switch in the BNC connector
- Self-powered 3 color tally system
- Low power consumption
- Case made of durable aluminum & steel
- Active matrix technology allows wide viewing angle
- Active matrix technology eliminates distortion
- Single A/C adaptor power supply provides power for all 4 monitors (included)
- Response Time: 10ms/10ms (Rising/Falling)

DVB-T features

DVB-T signal reception features:

- Automatic TPS signaling decoding;
- Fully compliant to all the standard Guard Intervals;
- Fully compliant to all the standard Code Rates
- Fully compliant to all the standard Constellations;
- Fast automatic 2k – 8k acquisition;
- Automatic spectral inversion.

DVB-T2 features

DVB-T2 signal reception features:

- Automatic L1 signaling decoding;
- Fully compliant to all the standard Guard Intervals;
- Fully compliant to all the standard Code Rates
- Fully compliant to all the standard Constellations;
- Provides manual selection of a single stream from single or multiple PLP input signal;
- Automatic output constant stream rate;

Other Features

Multi viewer provides the following monitoring and statistics:

- SNR estimation;
- MER measure;
- Pre LDPC BER;
- Pre BCH BER;
- Post BCH FER (FEC block Error Rate);
- Percentage signal quality;
- P1 parameters monitoring;
- L1 pre parameters monitoring;
- L1 post parameters monitoring;

Management of the devices is made through:

- Java GUI on Ethernet connection;
- SNMP agent (future release);
- Free front panel push button management

Physical Outputs

- 1 x SDI-SD Output
Connector: BNC
R Input: 75 Ohm
V Input: 800 mVpp (500 to 1200 mVpp)
Standard: SMPTE 259M,292M
- 1 x RGB-SD Outputs
3 Connector RCA (R,G,B)
- 1 x CVBS-SD Outputs
Composite Video Blanking Sync
Connector RCA
- 1 x HDMI-HD/SD Output
Connector HDMI Type A
- 1 x YUV-HD Output
3 Connector XLR (Y,U,V)
- 1 x Audio Output
2 audio connectors Left & Right

Audio/Video decoder features

Video standard supported:

- H.264/AVC: Level 4.1 high profile video decoder
- MPEG-2: MP@HL
- HD video resolution supported:

- 1920x180i30
- 1920x1080i25
- 1280x720p60
- 1280x720p50
- HD video resolution supported:
- PAL-BG: 720x576i25
- NTSC: 720x480i

Audio standard supported:

- MPEG-2, layer I
- MPEG-2, layer II

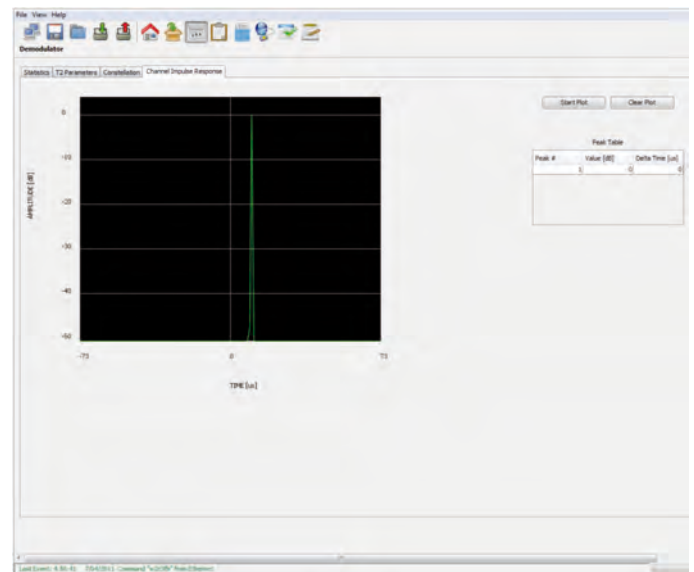

Java interface - Impulse Response

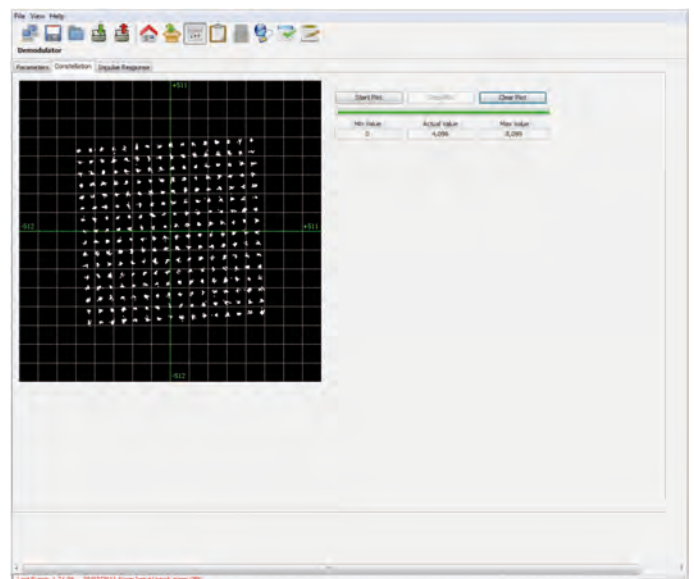

Java interface - Rotate Constellation



RF Portable Power Meter Probe



Power Probe

Description

The new Screen Service Agile RF Portable Power Probe offers accurate precision at all TV frequencies.

Easy to carry on and easy to connect, directly powered from USB, the New Power Meter Probe has an extraordinary user friendly interface which displays the output power simultaneously expressed in dBm and Watt.

Easy offset setting or accurate value readings.

it need only a common USB cable to power and communicate with normal PC (Windows or Linux SO)

Power Meter Probe is ideal for monitoring forward and reverse power distributed in digital broadcasting system.

Main Features

- Frequency Range: 10 MHz to 1 GHz
- Detection Range:-35 dBm to 5 dBm (Maximum Physical Input Signal: 15dBm)
- Accuracy: +/-0.5 dBm
- Exceptional Accuracy Over Temperature
- USB Powered
- Software Selectable Offset
- Aluminium Chassis
- Upgradable Firmware
- Dimensions: 11 cm x 5,5 cm / 2,1 inches x 4,2 inches
- Weight: 300g



Hardware Description:

- Connected: Green Led
- Pc Connected: yellow led
- Data Interface: Connector USB Type B



Rf Input: Connector Male type N

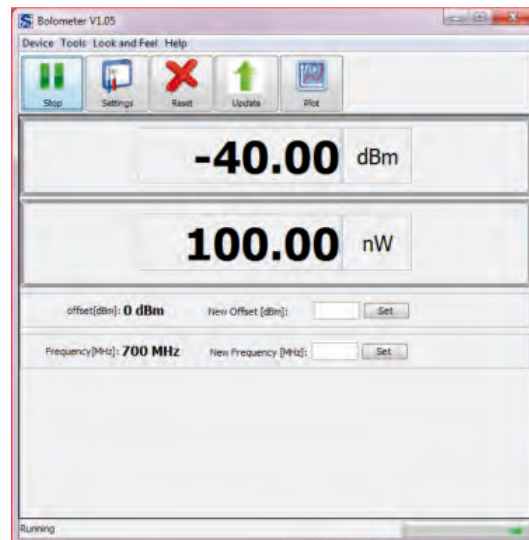

Java Software Interface

Digital Single Frequency Network analyzer



> SFN Analyzer

Description

SFN Concept : Same bits at the same time on the same frequency.

To ensure that all SFN transmitters comply with the time-specific synchronization and the transmit frequency, they are linked to a reference time standard. Global positioning system (GPS) information is provided for this purpose. But if GPS fails, for example, an intact transmitter may soon become the source of a failure. In this case, the transmit frequency and the set delay time of the transmitter will slowly drift, which finally leads to co-channel interference. This will also happen if the delay time or even the transmit frequency is incorrectly set due to an operator error on site. A frequency deviation of only a single hertz already significantly cuts down the system's security margin. In both cases, the resulting co-channel interference may cause reduced radio coverage, a loss of synchronization at a receiver, or even the complete failure of the TV broadcast service. This is why precise echo pattern and frequency deviation measurements are vital for efficient installation and operation of an SFN.

Main Features

- Allows in a simple manner and without need for additional tools to align a transmitter in a network SFN complex .
- It can perform measurements in service area where there is the contribution of two or more transmitters SFN, and in the presence of anomalies, which have a heavy decay the MER or, in cases "less serious", a distance between the echoes out of guard interval(measurement of the impulse response).
- GPS receivers inside
- Sat receivers with CAM for descrambling
- ASI Input
- RF Input

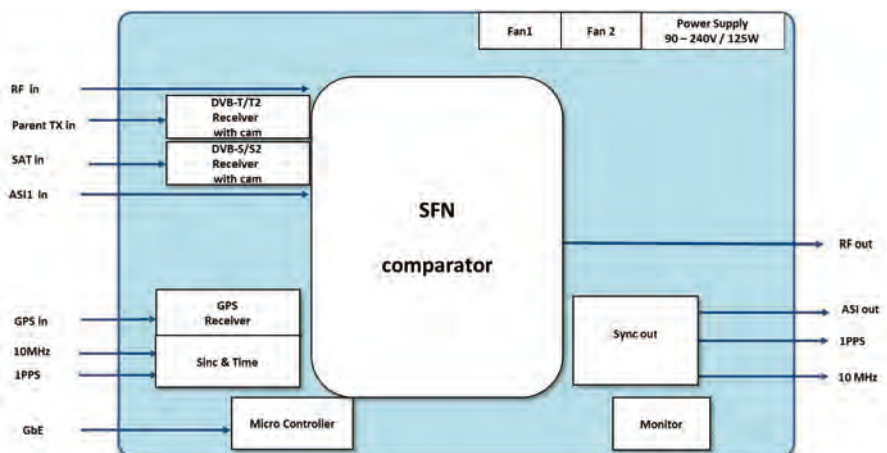

Professional GPS Tester for SFN Network



> GPS Tester

Description

It is a GPS (or any sync source, i.e. rubidium) validator for broadcasting.

GPS Tester is able to compare 2 different synchronization sources where one of the two can be used like a reference and the second one like the sync source under testing.

The equipment shows failure condition, such as:

- Phase jumps.
- Uncorrelated 10 MHz toward 1 PPS.
- Come back from holdover status.
- 1PPS jumps.
- 1PPS offset.
- Number of cycles among each 1PPS.
- Frequency drift.

SFN quality depends on 2 parameters: frequency stability and symbol timing. As center frequency drift, null shift across spectrum; this force receiver to re-compute channel equalization all the time - this will reduce the capability of set-top-boxes to receive clean pictures. Symbol timing can affect coverage in 2 different ways; first has an effect similar to center frequency instability. Timing errors have more important effect where we want to use the full power of SFN solutions. It is important to remember that SFN implies covering large areas and signal will not stop to affect coverage outside planned area; therefore, it is vital that we have enough margin. All transmitter received in a given area must fall within Guard interval or have a power ratio enough for demodulation.

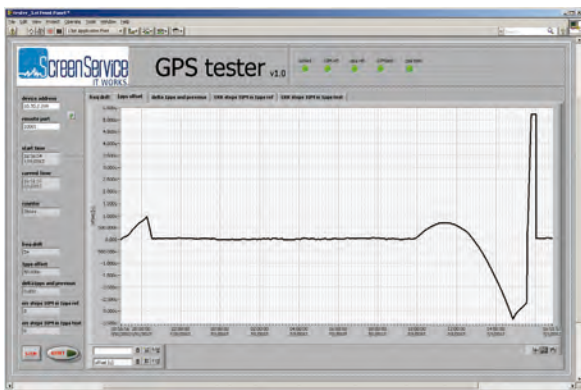

> GPS Tester Overview control software

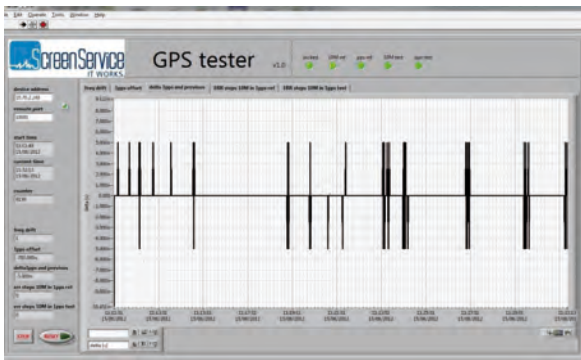

> Delta 1PPS and previous

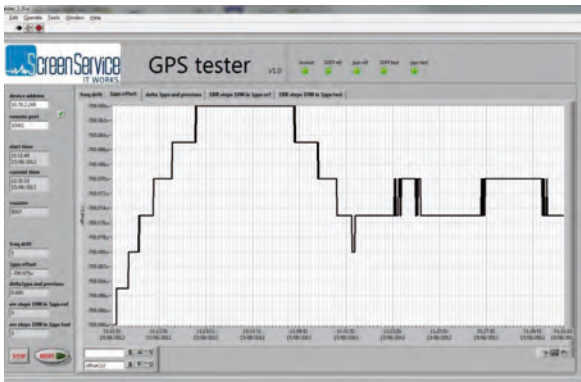

> 1PPS Offset

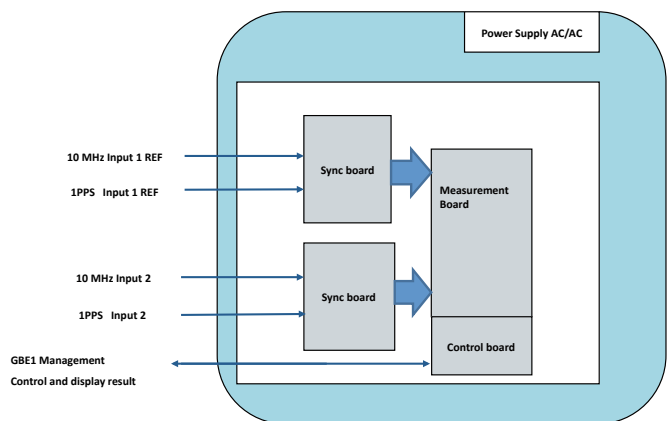

> GPS GTester Block Diagram

XBT 52 ASI Killer



> ASI Killer

Description

It allows in a simple manner and without need for additional tools to inject errors or delay in a TS.

Generated errors:

- Drop TS packet: delete one random packet from the TS
- Insert TS packet: insert one packet in a random position of the TS
- Drop byte: delete one random byte from the TS
- Insert byte: insert one byte in a random position of the TS
- Drop k28_5: generates an ASI word error
- Drop x47: delete the Sync byte of a random packet
- Change byte PAT: induce one error in the PAT
- Change byte PMT: induce one error in the PMT
- Change MIP: induce one error in the MIP

Induced delay:

- Delay TS packet: insert a delay as number of TS packets stored and forwarded
- Target delay: the delay time to be reached
- Actual delay: the delay time actually reached

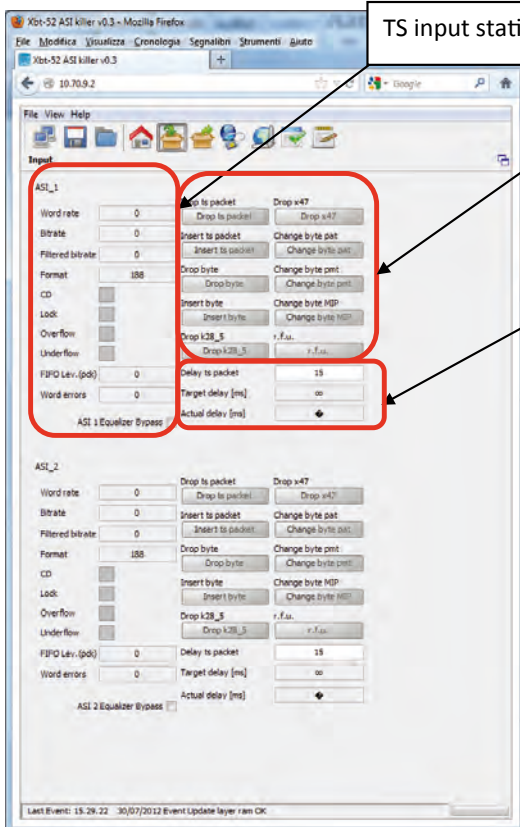

> ASI Killer Interface

TS input statistics

Generate errors

Induce delay

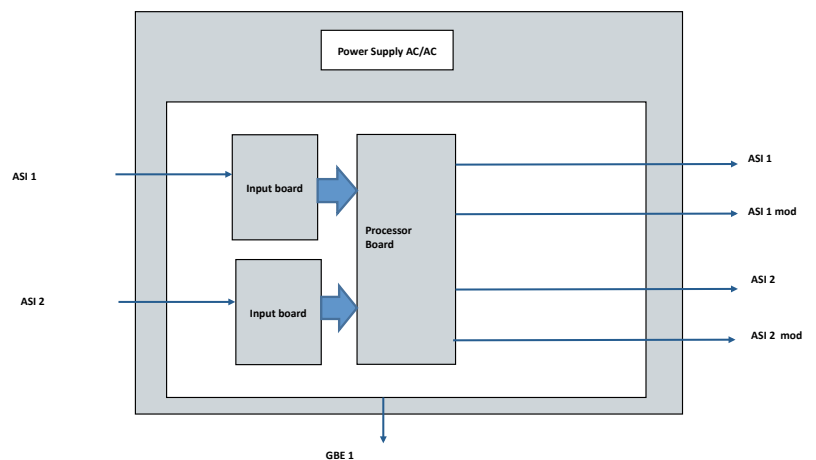

> ASI Killer Interface Block diagram



Professional TS Compare



> ASI Compare

Main Features

Inputs 2 selectable inputs between:

- 2 ASI
- 1 RF Satellite
- 2 RTP channels

Standard input data flow:

- TS (ISO-IE ---- C 138181.1) ISDBT BTS (ABNT NBR 15601)

Output Monitoring on BNC connector (ASI out), software selectable:

- Input 1 and 2 presence
- Alarm input difference
- Alarm input delay over threshold
- Alarm input PID 1 and PID 2 not present

Parameters Monitoring:

- Input 1 and 2 presence
- Alarm input difference
- Alarm input delay over threshold
- Alarm input PID 1 and PID 2 not present

Monitoring

- Input not present
- Identical Inputs
- Current inputs (standard)
- Delay Monitoring between inputs
- Data Packets Monitoring not identical

Clock Lock 10MHz synchronization possibility:

- Internal
- From 10 MHz external clock
- From GPS

INPUT/OUTPUT

INPUT

- ASI N° Inputs: 2
- (1 Input for 2 channels)
- Connector: BNC - R Input: 75 Ohm - V Input: 800 mVpp (500 to 1200mVpp) Standard: CEI EN 50083-9 / SMPTE 259M,292M

RF N° Inputs: 1

- RF Input : Tuning band from 950 MHz to 2150 MHz
- Rx Standard: DVB-S (ETSI EN 300 421) - DVB-S2 (ETSI TR 102 376)
- LNB power High Band - 10600 MHz Low Band - 9750 MHz
- DiSEqC (Vertical / Horizontal Polarization)
- Symbol Rate: DVB-S mode 4 to 30 Msps -DVB-S2 mode 10 to 30 Msps
- Modulation supported: DVB-S2 mode 8PSK/QPSK, LDPC+BCH - DVB-S mode QPSK, Viterbi + RS

OUTPUT

ASI N° Outputs: 1

- Connector: BNC R Input: 75 Ohm
- V Input: 800 mVpp (500 to 1200 mVpp) Standard: CEI EN 50083-9

Reference clock

- GPS 10 MHz 1 PPS

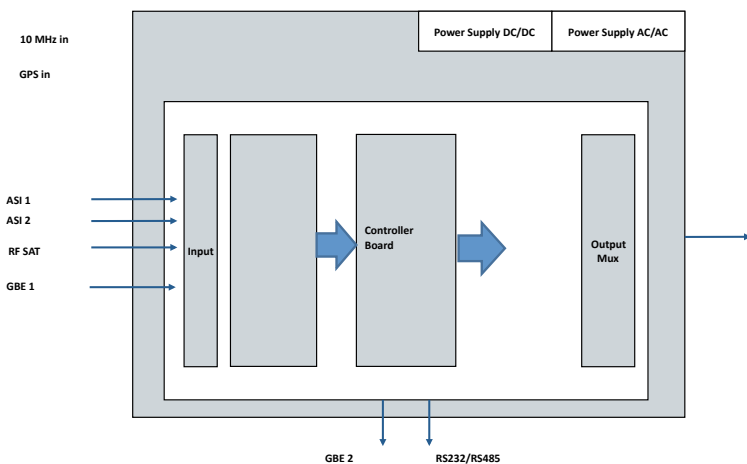

> TS Compare Block Diagram

SSBT Broadcast Analyzer



> Broadcast Analyzer 1RU for monitoring

Main Features

- ETR290 Analyzer
- Simultaneous monitoring of up to four RF signals
- RF modules for DVB-T/DVB-T2 and DVB-S/DVB-S2
- IP module for electrical and optical (SFP) connections
- Support for DVB, transport streams
- T2-MI support
- Simple operation and configuration

The SSBT Analyzer makes it possible to simultaneously monitor an 4 RF signal, 1 ASI signal And one IP flows.

Interface modules for DVB-T/DVB-T2, DVB-S/ DVB-S2 as well as for IP (optical/electrical) are available. All relevant errors at the RF, IP, TS and T2-MI level are recognized and reported immediately. Thumbnail display and electronic program guide (EPG) simplify visual monitoring of the transmitted contents. Remote access is supported via an integrated web server allowing independent, simultaneous access from different locations. SNMP and SNMP traps are supported for integration into central network management systems.

High-quality analysis functions and easy-to-understand displays complement the system's extensive array of monitoring functions. The analysis functions include program clock reference (PCR) analysis and buffer analysis

SSBT Broadcaster Analyzer family is a professional, attractively priced and compact solution for monitoring digital TV networks. Typical fields of applications are signal monitoring at the transmitter site, the satellite uplink or the head end.



> Broadcast Analyzer 2RU

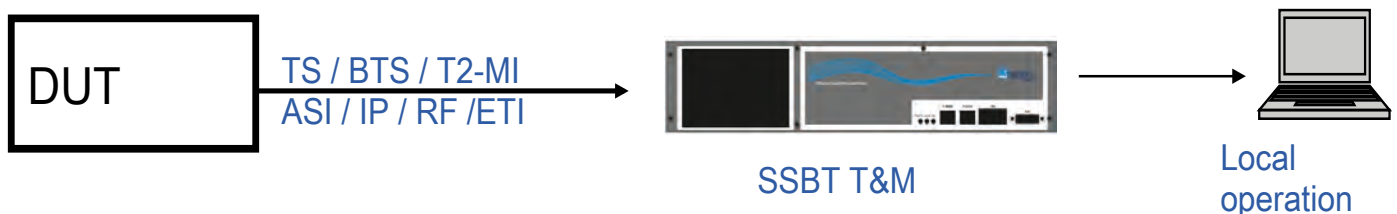

Transport stream analysis for developers and network operators



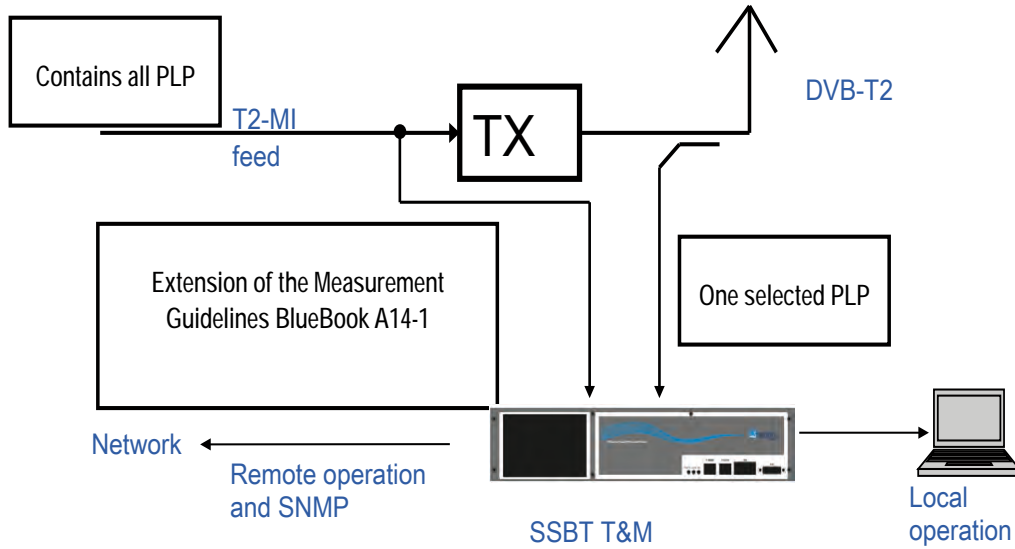

T2 TX Monitoring

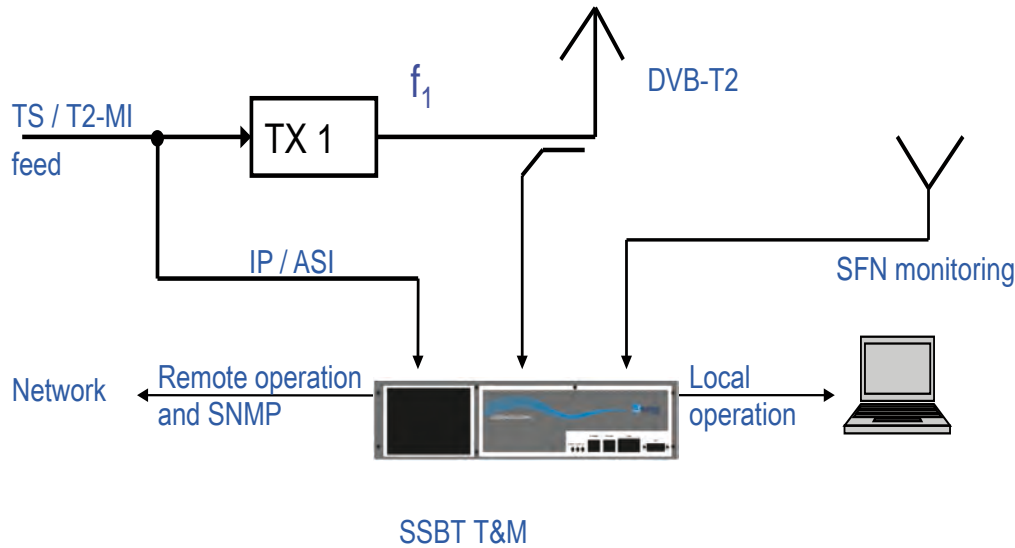

T2 TX Monitoring including SFN

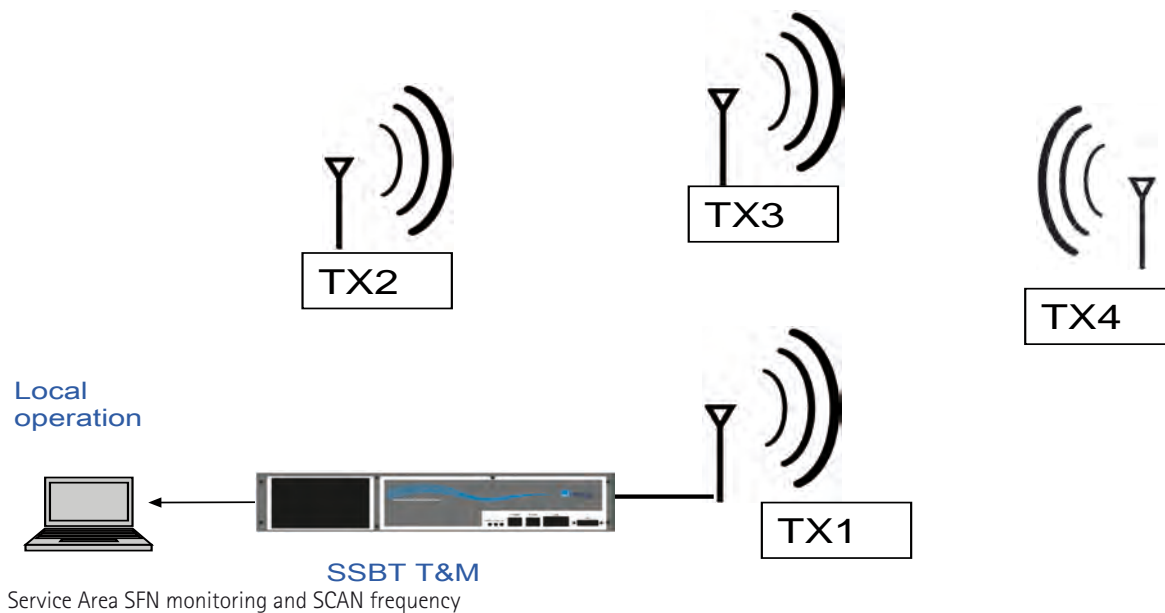

Service Area SFN monitoring and SCAN frequency

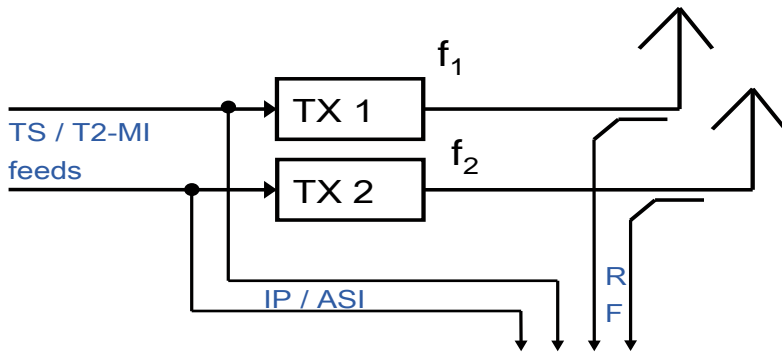

SSBT T&M

2 TX in DVB-T2 simultaneous monitoring with IP feed

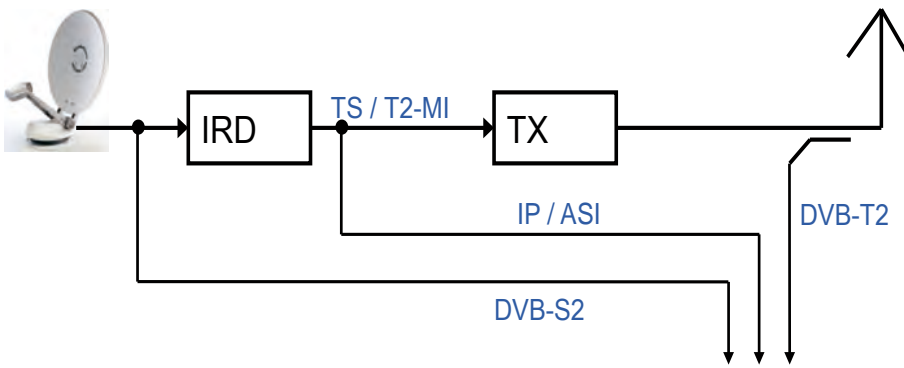

SSBT T&M

TX monitoring site with DVB-T2 TX and S2 feed

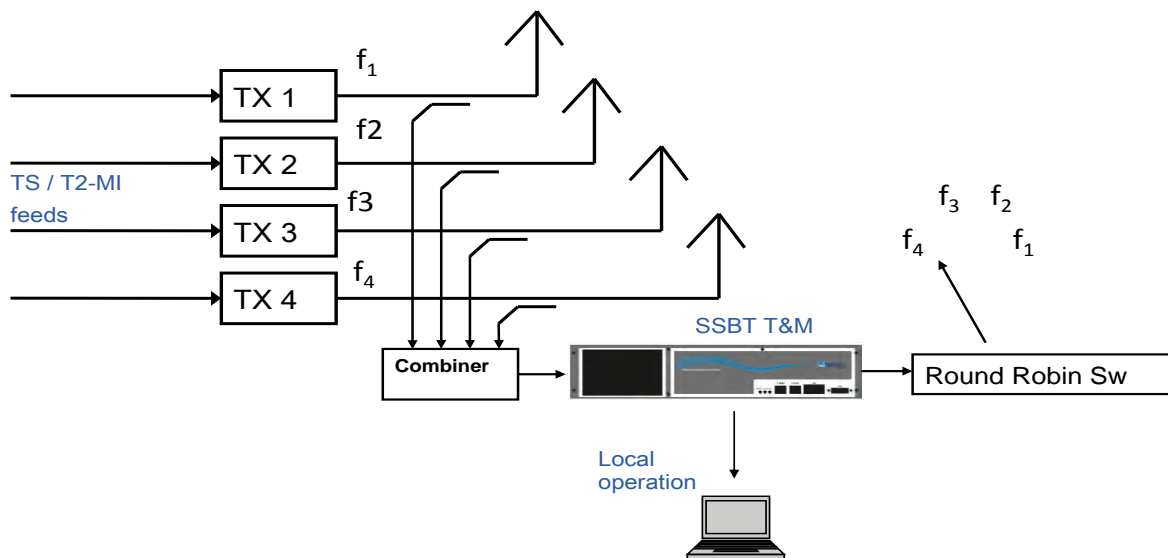

4 TX in DVB-T2 Simultaneous monitoring (round robin)



Features and Functions

Monitoring (simultaneous and uninterrupted real time measurements)

RF monitoring of various RF characteristics, including MER, BER and level, Constellation diagram.
RF transmission parameter monitoring comparison of the transmission parameters with predefined settings.
Shoulder attenuation monitoring of upper and lower shoulder (DVB-T and DVB-T2) (every s).
Echo pattern monitoring with level and timing of up to 8 impulses (DVB-T and DVB-T2) (every 10 to 25 s)

Monitoring of TR 101 290 priority 1, 2 and 3
Bit rates monitoring

TS modification detection of changes in the transport stream
EPG/EIT monitoring of the presence of EIT tables according to the signaling in the SDT tables and the template definitions

Analysis

Spectrum display (DVB-T and DVB-T2)
Echo pattern display of up to 8 impulses (DVB-T and DVB-T2)

EPG display of the electronic program guide based on all EIT tables received
Thumbnail display with lower frame rate for all unencrypted services and additional program details of one selected TS
PCR analysis of PCR accuracy, overall jitter, drift, offset and distance
PTS analysis

PID utilization with visualization of TS packet distribution within TS
PID list with list of all transport stream elements with detailed description

Operation

View selector: convenient selection of measurement displays
User rights management with protection against unauthorized use by defining user-specific operation rights
Event navigator with point- and click-based filtering of monitoring report
Hiding of events time-limited or unlimited suppression of monitoring results for specific measurements or PID's
Round robin monitoring for a predefined set of frequencies/channels using one input

Network functions

Remote display with remote access to SSBT GUI Viewer application Java-based remote access to monitoring results from different locations multiple user access.
SNMP simple network management protocol for integration into network management systems
Streaming of one selected PID or service to any point in the network (to any IP address)

Miscellaneous

High MER measurement increases the MER measurement for DVB-T and DVB-T2 to typ. 38 dB
TS capture with event-controlled recording of TS segments to hard disk
Logging to file of report entries to hard disk

The screenshot displays a software interface with the following sections:

- Contents summary:** A grid of video thumbnails for channels including CANALES PROVVISORIO, ITALIA1 PROVVISORIO, RETE4 PROVVISORIO, Boing, Cartoonito, and ClassTV MSNBC.
- Service rate summary:** A table showing service rates for various channels.

Service	Rate
Servizio 27	0.02% - 6,016 bit/s
Servizio 28	0.03% - 7,520 bit/s
Servizio 29	0.03% - 7,520 bit/s
Servizio 30	8.14% - 2,025,888 bit/s
Ghost	0.04% - 10,528 bit/s
CANALES PROVVISORIO	7.91% - 1,968,736 bit/s
ITALIA1 PROVVISORIO	6.20% - 1,541,600 bit/s
RETE4 PROVVISORIO	6.20% - 1,543,104 bit/s
Boing	8.87% - 2,207,872 bit/s
Cartoonito	8.88% - 2,209,376 bit/s
ClassTV MSNBC	8.14% - 2,025,888 bit/s
Mediaset HD	41.16% - 10,242,241 bit/s
- Tests summary:**
 - Errors after last update (1 sec.):
 - Errors after previous update (2+ sec.):
 - 2.3 PCR Error
 - 2.3b PCR Discontinuity Indicator Error
 - 2.5 PTS Error
 - 3.2 SI Repetition Error
 - 3.4 Unreferenced PID Error
 - 3.4a Unreferenced PID Error
- PID summary:** A table listing PID values and their bit rates.

PID	Rate
0x06f5 (1781)	Rate: 0.719% - 178976 bit/s
0x06fe (1790)	Rate: 5.446% - 1355104 bit/s
0x06ff (1791)	Rate: 0.719% - 178976 bit/s
0x0708 (1800)	Rate: 5.446% - 1355104 bit/s
0x0709 (1801)	Rate: 0.719% - 178976 bit/s
0x071c (1820)	Rate: 8.359% - 2080032 bit/s
0x071d (1821)	Rate: 0.496% - 123328 bit/s
0x0ab4 (2740)	Rate: 40.492% - 10075296 bit/s
0x0ab7 (2743)	Rate: 0.713% - 177472 bit/s
0x0baf (2991)	Rate: 0.054% - 13536 bit/s
0x187e (6270)	Rate: 0.006% - 1504 bit/s
0x1fff (8191)	Rate: 12.090% - 3008150 bit/s

> Simple User interface with Thumbnail display

The user interface has a clear structure and is very easy to operate. Configuration and operation are distinctly separated from each other. This makes work for the user fast and efficient. All monitoring functions and limits can be configured down to the very last detail.

Protection against unauthorized use is provided by defining user-specific operation rights.



The screenshot shows a software window titled 'main' with a status bar at the top right displaying '17:06:45'. The main area is divided into several sections:

- Left Panel:** A list of error types with corresponding status icons (green, yellow, red). The list includes:
 - 2.2 CRC Error (Green)
 - 2.3 PCR Error (Yellow)
 - 2.3a PCR Repetition Error (Green)
 - 2.3b PCR Discontinuity Indicator Error (Yellow)
 - 2.4 PCR Accuracy Error (Green)
 - 2.5 PTS Error (Yellow)
 - 2.6 CAT error (Green)
 - Priority 3 (Red)
 - 3.1 NIT Error (Green)
 - 3.1a NIT Actual Error (Green)
 - 3.1b NIT Other Error (Green)
 - 3.2 SI Repetition Error (Red)
 - 3.3 Buffer Error (Green)
 - 3.4 Unreferenced PID Error (Yellow)
 - 3.4a Unreferenced PID Error (Yellow)
 - 3.5 SDT Error (Green)
 - 3.5a SDT Actual Error (Green)
 - 3.5b SDT Other Error (Green)
 - 3.6 EIT Error (Green)
 - 3.6a EIT Actual Error (Green)
 - 3.6b EIT Other Error (Green)
 - 3.6c EIT PF Error (Green)
 - 3.7 RST Error (Green)
 - 3.8 TDT Error (Green)
 - 3.9 Empty Buffer Error (Green)
 - 3.10 Data Delay Error (Green)
- Details Section:**
 - Errors after last update (1 sec.):** This section is currently empty.
 - Errors after previous update (2+ sec.):** This section contains a legend:
 - Red circle: 3.2 SI Repetition Error
 - Yellow circle: 3.4 Unreferenced PID Error
 - Yellow circle: 3.4a Unreferenced PID Error
- Table:** A table with two columns: 'Timestamp' and 'Description'. It lists numerous error events, all of which are 'Maximum time interval between sections over 500ms' for various PIDs and tables. The most recent entry is at timestamp 2012-09-19T17:06:45.
- Bottom Right:** Two buttons labeled 'Reset' and 'Close'.

Monitoring of DVB specific TS

DVB transport streams are monitored in line with the TR 101 290 measurement guidelines. All measurements specified in the TR 101 290 measurement guidelines under priorities 1, 2 and 3 are carried out simultaneously for every component of all transport streams being monitored

Contacts

Screen Service Broadcasting Technologies SpA

Screen Service Broadcasting Technologies Spa
Headquarters

Via G. Di Vittorio, 17 - 25125 Brescia - Italy

R&D Labs

Via Lepetiti, 40 - 20020 Lainate (Milano) - Italy

www.screen.it

Phone: +39 030 57831

Fax: +39 030 5783888

Sales

Sales@screen.it

Marketing

Marketing@screen.it

Technical Support

technical.office@screen.it

support@screen.it

Skylinks

Skylinks Srl

SS per Voghera Reg. Villoria 93/5F
15057 Tortona (AL) - Italy

www.skylinks.it

Phone: +39 0131 821235

Fax: +39 0131 8662248

Sales

sales@skylinks.it

Tivuitalia SpA

Tivuitalia Srl

Head Office

Via G. Di Vittorio, 17 - 25125 Brescia Italy

Headquarters

Via Lepetiti,40 - 20020 Lainate (Milano) - Italy

www.tivuitalia.net

Phone: +39 03057831

Fax: +39 0305783888

Info

broadcast@tivuitalia.net



Screen Service America Llc

Screen Service America Llc
6095 NW 167th Street, Suite D-10 - Miami, FL 33015 USA
Phone: +1 (305) 826-2212
Fax: +1 (305) 826-2290
USA Toll Free 1-888-522-0012
www.screenservice.net

Sales
Sales@screen.it

Info
info@screenservice.net

Screen Service Do Brasil Ltda

Screen Service do Brasil Ltda
Av. dos Alecrins 740
Distrito Industrial Tuany Toledo
Pouso Alegre - MG - Brasil
CEP 37550-000
Phone : +55 (35) 2102-3100
www.screenbrasil.com.br

Info
info@screenbrasil.com.br





SCREEN SERVICE BROADCASTING TECHNOLOGIES S.p.A.
Via G. Di Vittorio, 17 - 25125 Brescia Italy
Tel +39 030 57831 - Fax +39 030 5783888
info@screen.it - www.screen.it